

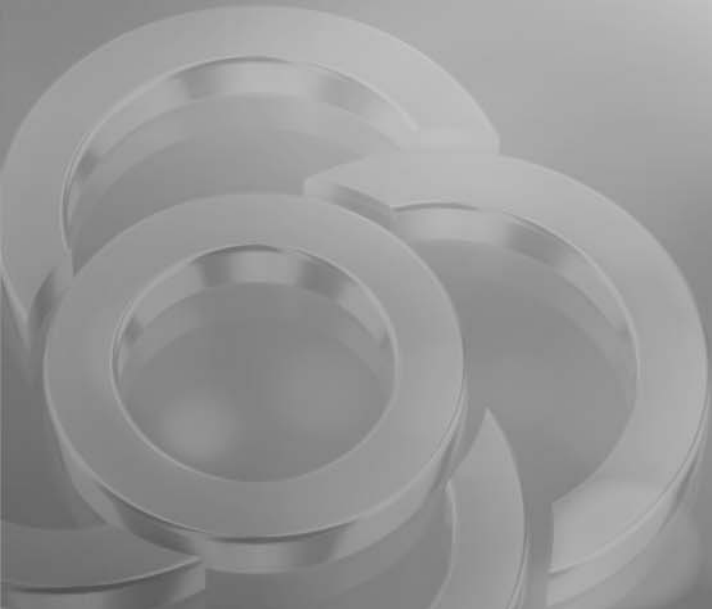

ÜRÜN KATALOĐU



Güvenli,
uzun ömürlü
ve doğayla
barışık!



Firmamızın kuruluşu 2001 yılında gerçekleştirildi. Kalite, hız, ekip çalışması ve verilen garanti ile büyüyen referanslarımız, son yıllarda yatırıma ve kurumsal kimlik çalışmalarına ağırlık vermemize yol açtı. Türkiye'nin enerji uzmanları tarafından dünyanın en hızlı gelişen on pazarından biri olarak gösterilmesi, firmamızı paslanmaz çelik ürünlerini kapsayan bu sektöre yatırım yapılmasını teşvik etmiştir.

Amacımız, yeni teknolojiler ile güvenilir ve yüksek kalite seviyelerine ulaşmak için durmaksızın çaba harcayan bir üretici olmak ve buna bağlı hızlı, güçlü ve yenilik geleneğine sahip bir pazarlama ağı kurmaktır. Bu da; ticari v e

sınâî olarak, şirket, çalışanları ve müşteriler için yeni fırsatlar oluşturacaktır.

Yeni teknolojiler ile üretilen ürünler piyasaya güvenle sunulacaktır. Öncelik şu anda tüm dünyanın kullanmakta olduğu teknoloji ile üretilen ürünlerin aynı anda Türkiye'de üretiminin sağlanması, müşterilerin beğenisine ve Türk halkının istifadesine sunulmasıdır. Türkiye'deki doğalgaz ve havalandırma sektöründe sürekli gelişmeyi hedefleyen SOLİNOX mevcut ve yeni inşa edilecek yapılarda yaşam standartlarını yükseltmeyi, yaşanılan yerlerin güvenliğini ve konforunu artırmayı, dayanıklılığını ve ömrünü uzatmayı amaç edinmiştir. Müşterilerinin teknik danışmanı ve çözüm ortağı olmayı benimseyen, sorunlara ve ihtiyaçlara birlikte çıkış yolu arayan SOLİNOX kaliteyi ve müşteri memnuniyetini her zaman ön planda tutmaktadır.



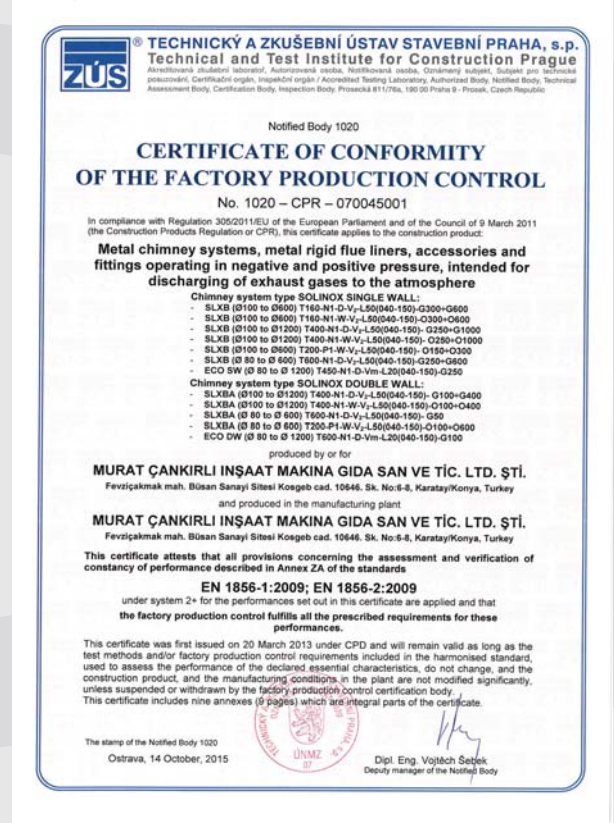

SOLİNOX markası olarak, üretimi gerçekleşen tüm ürünlerin Avrupa standartlarına uygun belgelendirme çalışmaları tamamlanmış olup; CE-EN 1856-1, CE-EN1856-2 ve ISO 9001:2015 belgeleri ile tescillenmiştir.



Yanma sonucu oluşan atık gazların güvenli ve sağlıklı bir şekilde atmosfere bırakılmasını sağlayan sisteme baca sistemi adı verilir.

Bacalar yakıt sistemini oluşturan en önemli parçalardan biridir. Bacalar aynı zamanda düzgün yanmanın gerçekleşebilmesi için gerekli olan hava teminini sağladığı için de verimliliğin sağlanması bakımından önemli bir konumdadır. Bu sebeplerden dolayı baca sistemleri tasarlanırken bütün dinamikler göz önünde bulundurulmalı ve tasarım her açıdan kusursuz olmalıdır.

Baca içerisinden geçen atık gazlar içerisinde pek çok kimyasal bulundururlar. Bu kimyasal atıklar izledikleri yol boyunca baca sistemini korozyona uğratma, çürütme, paslanma gibi ciddi zararlar verebilir. Bu zarardan bacayı korumak ve sistemin devamlılığını sağlamak adına; bacalarda standartlara uygun paslanmaz çelik ürünler (AISI 316L 1.4404 – AISI 304 1.4301) kullanılmalıdır.

PASLANMAZ ÇELİK BACALARIN AVANTAJLARI;

- Hafiftir.
- Hızlı ve kolay kurulum.
- Korozyona, çürümeye dayanıklıdır ve nemden etkilenmez.
- Bütün yakıt tiplerine uygundur.
- Pürüzsüz yapısı nedeniyle kurum oluşmasını engeller.
- Tam sızdırmazlık sağlar.
- Asitlerin yıkıcı etkilerine karşı dayanıklıdır.
- Görünüm açısından estetikdir.
- Bina içi ve bina dışı kurulumlar için uygundur.
- Kolay kontrol ve temizlik yapılabilir.

BACA BİLEŞENLERİ

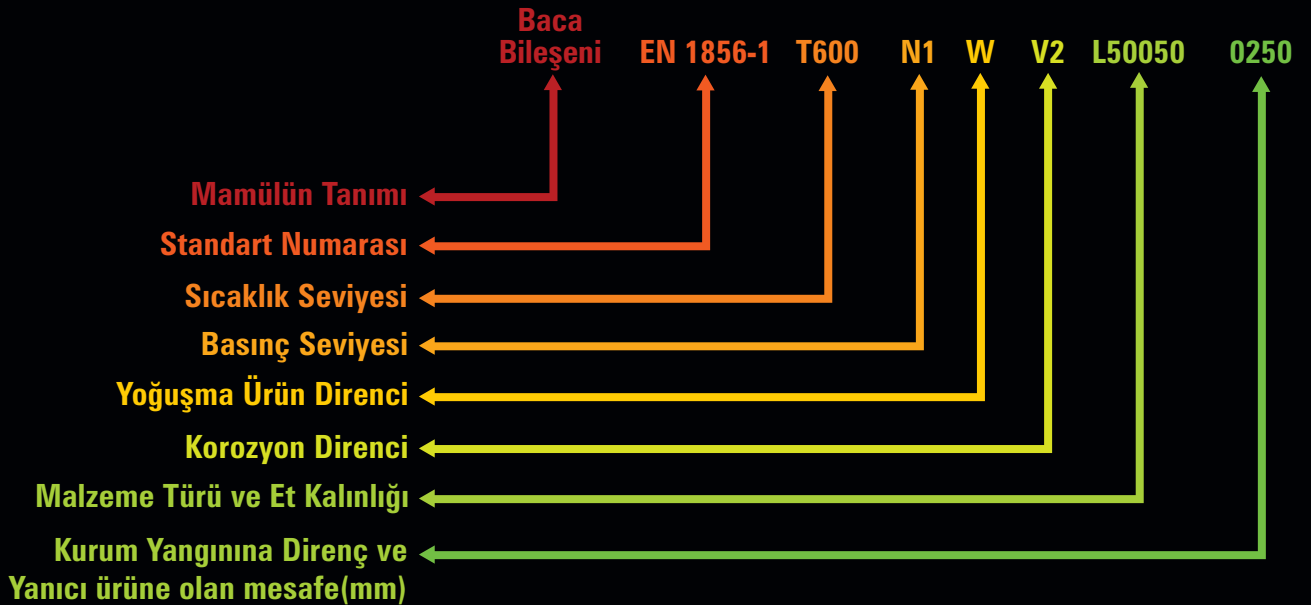

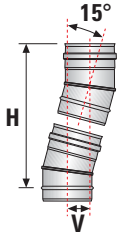
Dirsek (15°) x 2

Ø	H	V
100	300	38
130	309	39
150	313	39
180	372	42
200	377	43
230	383	44
250	390	45
300	404	47
350	416	48
400	429	50
450	442	52

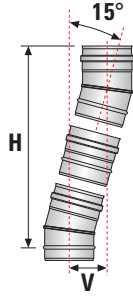
Boru 250 + Dirsek (15°) x 2

Ø	H	V
100	495	91
130	500	91
150	507	91
180	567	93
200	572	93
230	578	94
250	584	95
300	598	98
350	610	99
400	623	100
450	636	103

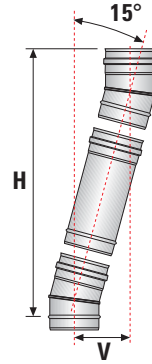
Boru 500 + Dirsek (15°) x 2

Ø	H	V
100	735	155
130	745	155
150	748	155
180	808	157
200	813	157
230	820	158
250	827	159
300	839	161
350	852	163
400	865	164
450	878	166

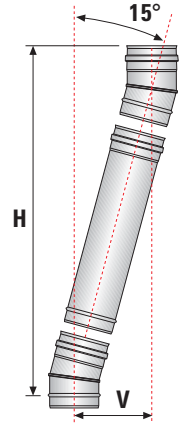
Boru 1000 + Dirsek (15°) x 2

Ø	H	V
100	1220	284
130	1223	285
150	1231	285
180	1291	287
200	1296	287
230	1302	288
250	1308	289
300	1322	292
350	1335	293
400	1348	295
450	1360	297

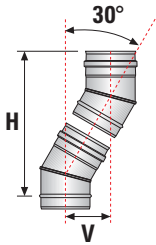
Dirsek (30°) x 2

Ø	H	V
100	311	84
130	325	88
150	336	90
180	350	95
200	361	97
230	374	100
250	386	104
300	410	107
350	434	116
400	460	123
450	485	130

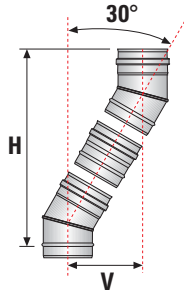
Boru 250 + Dirsek (30°) x 2

Ø	H	V
100	484	184
130	500	188
150	509	190
180	524	194
200	534	197
230	547	200
250	559	204
300	584	210
350	605	219
400	630	226
450	655	232

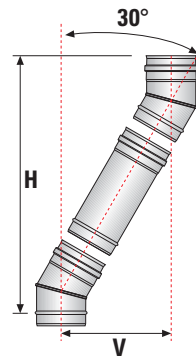
Boru 500 + Dirsek (30°) x 2

Ø	H	V
100	700	309
130	716	313
150	726	315
180	733	320
200	750	322
230	763	326
250	775	329
300	800	335
350	822	344
400	846	350
450	871	357

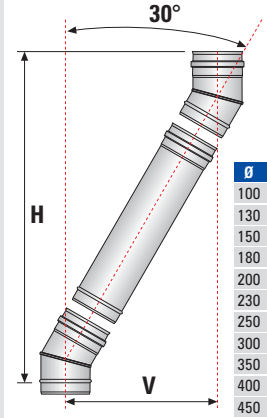
Boru 1000 + Dirsek (30°) x 2

Ø	H	V
100	1133	558
130	1148	562
150	1158	565
180	1165	567
200	1183	572
230	1195	575
250	1208	578
300	1233	585
350	1255	594
400	1279	600
450	1304	607

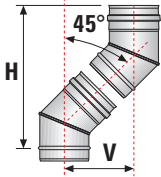
Dirsek (45°) x 2

Ø	100	130	150	180	200	230	250	300	350	400	450
H	309	330	344	366	380	397	415	450	486	521	556
V	129	137	143	152	158	165	173	187	203	217	231

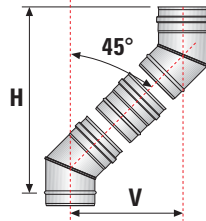
Boru 250 + Dirsek (45°) x 2

Ø	100	130	150	180	200	230	250	300	350	400	450
H	450	472	486	508	522	539	557	592	628	663	698
V	270	278	285	293	300	307	314	328	343	357	372

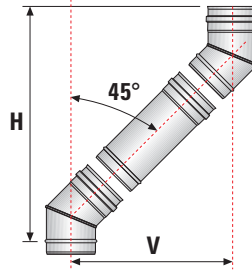
Boru 500 + Dirsek (45°) x 2

Ø	100	130	150	180	200	230	250	300	350	400	450
H	627	649	663	684	698	716	734	780	804	840	875
V	447	455	460	470	476	483	490	505	519	534	589

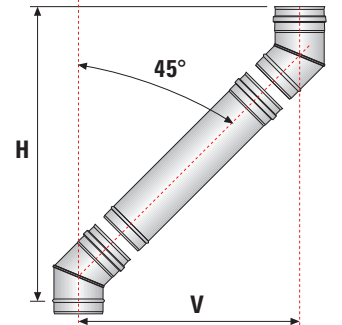
Boru 1000 + Dirsek (45°) x 2

Ø	100	130	150	180	200	230	250	300	350	400	450
H	981	1000	1016	1038	1052	1069	1087	1122	1158	1193	1228
V	800	810	815	823	830	837	844	859	873	888	903

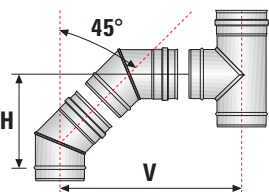
T90 + Dirsek (45°) x 2

Ø	130	150	180	200	230	250	300	350	400	450
H	243	218	233	243	256	268	293	318	343	368
V	393	375	403	422	445	468	513	579	605	650

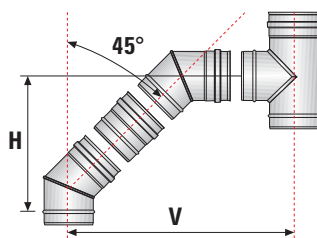
T90+Boru 250 + Dirsek (45°) x 2

Ø	130	150	180	200	230	250	300	350	400	450
H	350	360	375	385	398	410	435	460	485	510
V	500	517	545	563	586	609	656	720	746	790

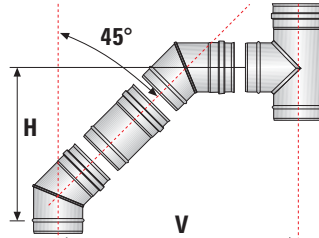
T90+Boru 500 + Dirsek (45°) x 2

Ø	130	150	180	200	230	250	300	350	400	450
H	527	537	552	562	575	587	612	637	662	687
V	676	694	722	740	763	785	830	897	922	967

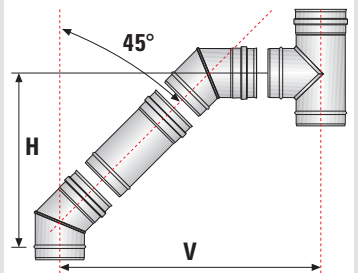
T90+Boru 1000 + Dirsek (45°) x 2

Ø	130	150	180	200	230	250	300	350	400	450
H	880	890	905	915	928	940	965	990	1015	1040
V	1029	1047	1075	1093	1117	1140	1184	1250	1276	1321

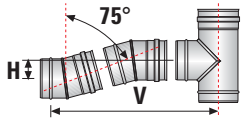
T90 + Dirsek (15°) x 2

Ø	130	150	180	200	230	250	300	350	400	450
H	41	41	42	43	44	45	47	48	50	52
V	406	420	440	454	482	490	520	575	588	621

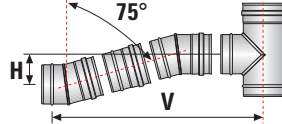
T90+Boru 250 + Dirsek (15°) x 2

Ø	130	150	180	200	230	250	300	350	400	450
H	92	93	94	95	96	97	99	100	102	104
V	598	613	633	647	663	680	714	768	781	814

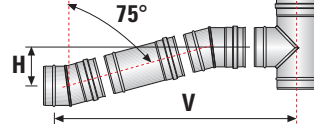
T90+Boru 500 + Dirsek (15°) x 2

Ø	130	150	180	200	230	250	300	350	400	450
H	157	158	184	160	161	162	163	165	167	168
V	839	854	875	888	905	922	955	1010	1023	1056

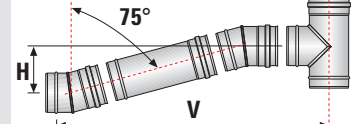
T90+Boru 1000 + Dirsek (15°) x 2

Ø	130	150	180	200	230	250	300	350	400	450
H	286	287	289	289	290	291	293	295	296	298
V	1322	1337	1358	1371	1388	1405	1438	1493	1506	1539

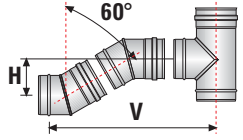
T90 + Dirsek (30°) x 2

Ø	130	150	180	200	230	250	300	350	400	450
H	88	90	95	97	102	104	111	117	124	131
V	423	442	470	488	511	534	579	646	671	716

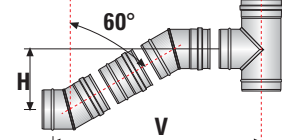
T90+Boru 250 + Dirsek (30°) x 2

Ø	130	150	180	200	230	250	300	350	400	450
H	188	190	195	197	200	204	211	217	224	231
V	597	615	643	660	683	707	752	819	844	889

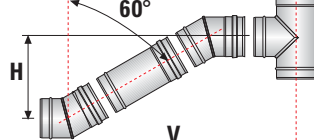
T90+Boru 500 + Dirsek (30°) x 2

Ø	130	150	180	200	230	250	300	350	400	450
H	313	316	320	322	325	329	336	342	349	356
V	813	831	859	877	900	923	963	1035	1060	1105

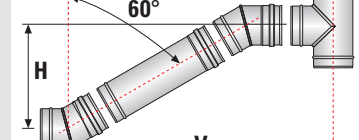
T90+Boru 1000 + Dirsek (30°) x 2

Ø	130	150	180	200	230	250	300	350	400	450
H	563	566	570	572	575	579	586	592	599	606
V	1246	1264	1292	1310	1333	1356	1400	1468	1493	1538

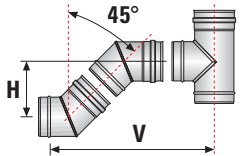
T90 + Dirsek (45°) x 2

Ø	130	150	180	200	230	250	300	350	400	450
H	173	143	152	158	166	173	188	202	216	231
V	464	450	484	506	535	563	618	696	731	786

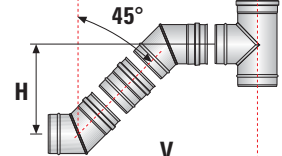
T90+Boru 250 + Dirsek (45°) x 2

Ø	130	150	180	200	230	250	300	350	400	450
H	279	285	294	300	307	315	329	344	359	373
V	569	591	625	648	676	704	759	837	872	928

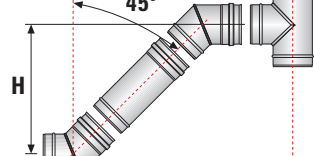
T90+Boru 500 + Dirsek (45°) x 2

Ø	130	150	180	200	230	250	300	350	400	450
H	456	462	471	476	483	491	506	521	535	550
V	746	768	802	824	853	881	936	1013	1049	1104

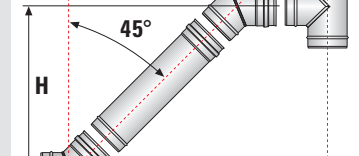
T90+Boru 1000 + Dirsek (45°) x 2

Ø	130	150	180	200	230	250	300	350	400	450
H	810	815	824	830	838	845	860	874	888	903
V	1100	1122	1156	1178	1207	1235	1290	1367	1402	1458

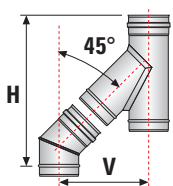
T45 + Dirsek (45°) x 1

Ø	130	150	180	200	230	250	300	350	400	450
H	670	682	693	705	715	724	732	743	750	764
V	302	310	316	328	339	347	352	364	371	388

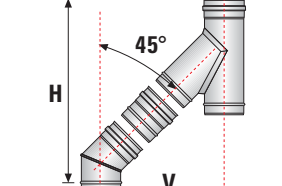
T45+Boru 250 + Dirsek (45°) x 1

Ø	130	150	180	200	230	250	300	350	400	450
H	810	818	826	835	842	856	869	873	880	893
V	440	450	456	460	467	472	480	486	493	502

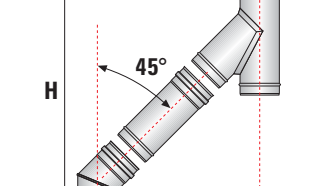
T45+Boru 500 + Dirsek (45°) x 1

Ø	130	150	180	200	230	250	300	350	400	450
H	985	995	1010	1016	1032	1042	1056	1068	1080	1100
V	613	620	629	635	642	661	673	680	685	701

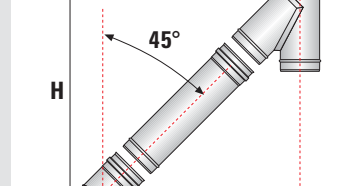
T45+Boru 1000 + Dirsek (45°) x 1

Ø	130	150	180	200	230	250	300	350	400	450
H	1350	1363	1376	1390	1405	1415	1425	1430	1440	1457
V	970	980	992	1005	1012	1023	1039	1047	1058	1068

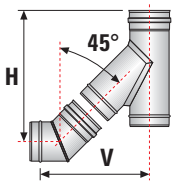
T45 + Dirsek (45°) x 1

Ø	130	150	180	200	230	250	300	350	400	450
H	660	672	683	695	705	714	722	733	740	754
V	272	280	286	298	309	317	322	334	341	358

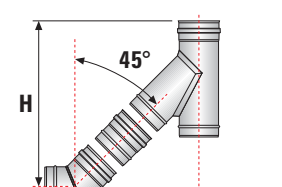
T45+Boru 250 + Dirsek (45°) x 1

Ø	130	150	180	200	230	250	300	350	400	450
H	760	768	776	785	792	806	819	823	830	843
V	405	415	421	425	432	437	445	451	458	467

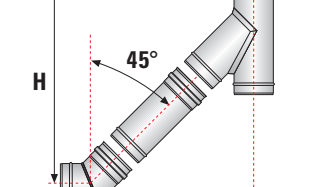
T45+Boru 500 + Dirsek (45°) x 1

Ø	130	150	180	200	230	250	300	350	400	450
H	975	985	1000	1006	1022	1032	1046	1058	1070	1090
V	578	585	594	600	607	626	638	645	650	666

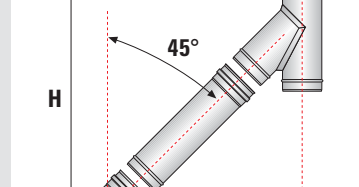
T45+Boru 1000 + Dirsek (45°) x 1

Ø	130	150	180	200	230	250	300	350	400	450
H	1340	1353	1366	1380	1395	1405	1415	1420	1430	1447
V	920	930	942	955	962	973	989	997	1008	1018



TEMEL ÖZELLİKLER

- Kolay ve hızlı kurulum.
- Şaft içi uygulamalar için elverişli.
- **Muf** : 50 mm.
- **Kaynak Türü** : Sürekli TiG Kaynağı.
- **Kalınlık** : 0.40 mm – 1.50 mm.
- **Bağlantı Tipi** : Erkek / Dişi Bağlantılar.
- **Çap Aralığı** : Ø 80 mm'den 1200 mm'ye Kadar.

TEKNİK ÖZELLİKLER

- **Çalışma türü** : Islak (W) (contalı kullanım)
Kuru (D) (contasız kullanım)
- **Basınç türü** : Pozitif (P1) (contalı kullanım)
Negatif (N1) (contasız kullanım)
- **Max. çalışma basıncı** : 200 Pa
- **Çalışma sıcaklığı** : 200 °C
600°C
- **Malzeme** : AISI 316L (1.4404)
AISI 304 (1.4301)
- **Yakıt tipi** : Doğalgaz / Katı yakıt / Sıvı yakıt

UYGULAMA ALANLARI

- Merkezi ısıtma ve sıcak su sistemleri
- Endüstriyel ve ticari baca sistemleri
- Ekmek fırınları
- Şömineler
- Havalandırmalar



1020

SERTİFİKALAR

T160-N1-W-V2-L50 (040-150)-0300÷0600
T160-N1-D-V2-L50 (040-150)-G300÷G600
T200-P1-W-V2-L50 (040-150)-0150÷0300
T400-N1-D-V2-L50 (040-150)-G250÷G1000
T400-N1-W-V2-L50 (040-150)-0250÷01000
T600-N1-D-V2-L50 (040-150)-G250-G600
T450-N1-D-Vm-L20 (040-150)-G250

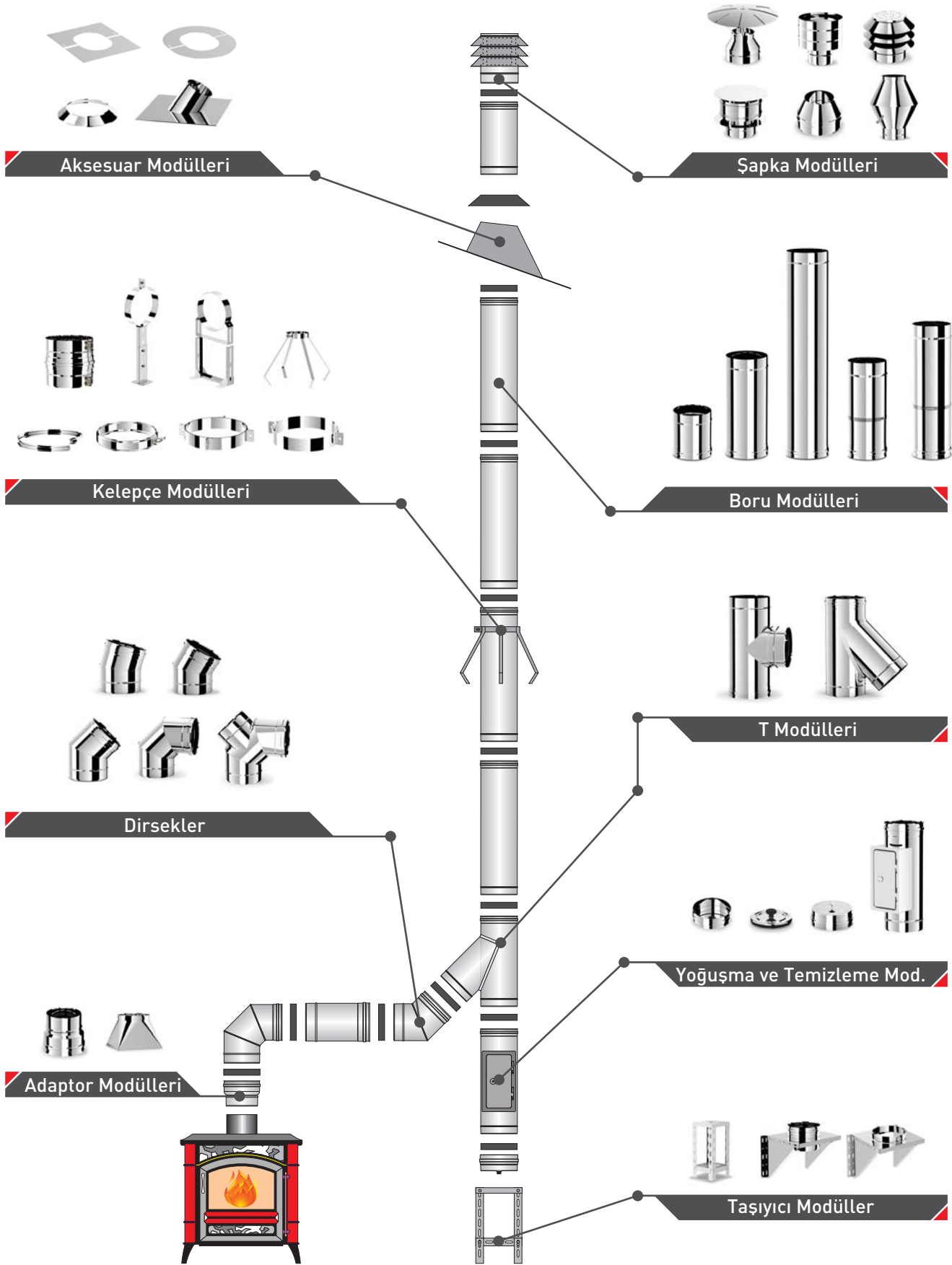

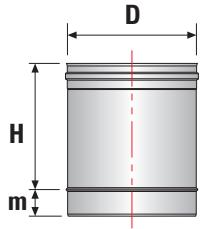

SLXB250 Düz Boru 250 mm

D	80	100	130	150	180	200	230	250	280	300	350	400	450	500	550	600
H	200	200	200	200	200	200	200	200	200	200	200	200	200	200	200	200
m	50	50	50	50	50	50	50	50	50	50	50	50	50	50	50	50

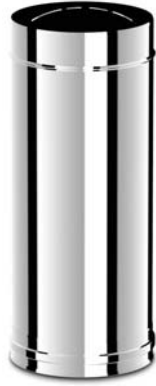
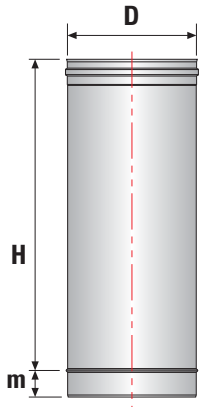

SLXB500 Düz Boru 500 mm

D	80	100	130	150	180	200	230	250	280	300	350	400	450	500	550	600
H	450	450	450	450	450	450	450	450	450	450	450	450	450	450	450	450
m	50	50	50	50	50	50	50	50	50	50	50	50	50	50	50	50

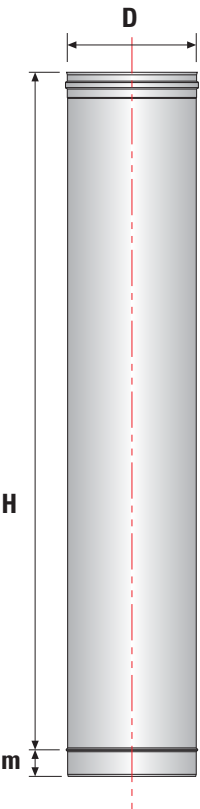

SLXB1000 Düz Boru 1000 mm

D	80	100	130	150	180	200	230	250	280	300	350	400	450	500	550	600
H	950	950	950	950	950	950	950	950	950	950	950	950	950	950	950	950
m	50	50	50	50	50	50	50	50	50	50	50	50	50	50	50	50

SLXUB47 Teleskopik Boru Çeyrek 270-470 mm

D	80	100	130	150	180	200	230	250	280	300	350	400	450	500	550	600
Min	240	240	240	240	240	240	240	240	240	240	240	240	240	240	240	240
Max	420	420	420	420	420	420	420	420	420	420	420	420	420	420	420	420
m	50	50	50	50	50	50	50	50	50	50	50	50	50	50	50	50

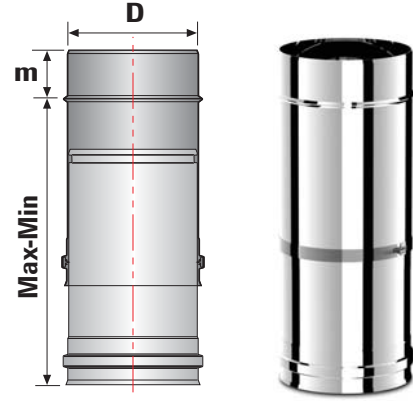

SLXUB90 Teleskopik Boru Yarım 550-900 mm

D	80	100	130	150	180	200	230	250	280	300	350	400	450	500	550	600
Min	490	490	490	490	490	490	490	490	490	490	490	490	490	490	490	490
Max	920	920	920	920	920	920	920	920	920	920	920	920	920	920	920	920
m	50	50	50	50	50	50	50	50	50	50	50	50	50	50	50	50

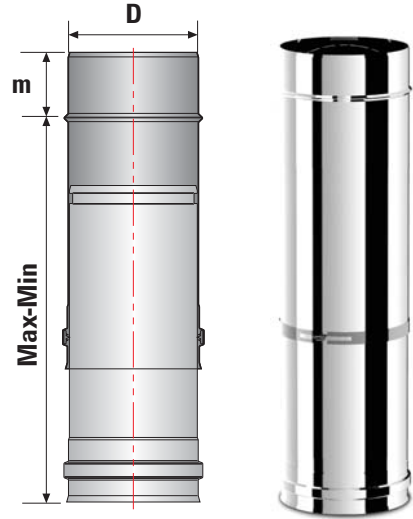

DİRSEKLER

SLXD15 15° Dirsek

D	80	100	130	150	180	200	230	250	280	300	350	400	450	500	550	600
A	109	110	113	114	116	118	120	133	135	137	140	143	154	157	160	164
B	109	110	113	114	116	118	120	133	135	137	140	143	154	157	160	164
m	50	50	50	50	50	50	50	50	50	50	50	50	50	50	50	50

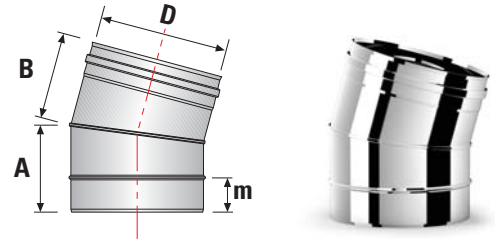

SLXD30 30° Dirsek

D	80	100	130	150	180	200	230	250	280	300	350	400	450	500	550	600
A	110	117	133	136	140	144	160	162	166	181	188	207	214	235	242	261
B	110	117	133	136	140	144	160	162	166	181	188	207	214	235	242	261
m	50	50	50	50	50	50	50	50	50	50	50	50	50	50	50	50

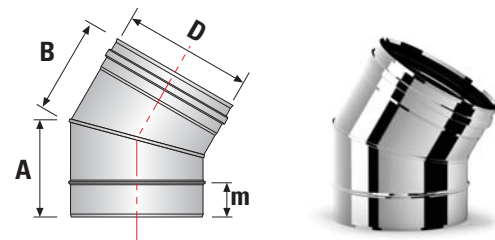

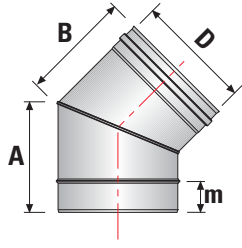

SLXD45 45° Dirsek

D	80	100	130	150	180	200	230	250	280	300	350	400	450	500	550	600
A	115	138	155	160	179	180	190	205	211	216	241	264	292	308	332	372
B	115	138	155	160	179	180	190	205	211	216	241	264	292	308	332	372
m	50	50	50	50	50	50	50	50	50	50	50	50	50	50	50	50

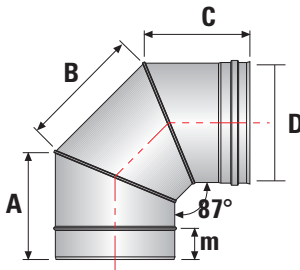

SLXD87 87° Dirsek

D	80	100	130	150	180	200	230	250	280	300	350	400	450	500	550	600
A	110	123	135	150	165	170	187	187	212	217	235	255	277	300	317	342
B	112	146	173	189	214	222	255	270	280	312	353	395	437	479	520	560
C	110	123	135	150	165	170	187	187	212	217	235	255	277	300	317	342
m	50	50	50	50	50	50	50	50	50	50	50	50	50	50	50	50

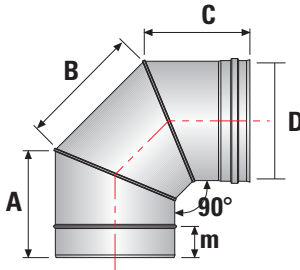

SLXD90 90° Dirsek

D	80	100	130	150	180	200	230	250	280	300	350	400	450	500	550	600
A	110	123	135	150	165	170	187	187	212	217	235	255	277	300	317	342
B	112	146	173	189	214	222	255	270	280	312	353	395	437	479	520	560
C	110	123	135	150	165	170	187	187	212	217	235	255	277	300	317	342
m	50	50	50	50	50	50	50	50	50	50	50	50	50	50	50	50

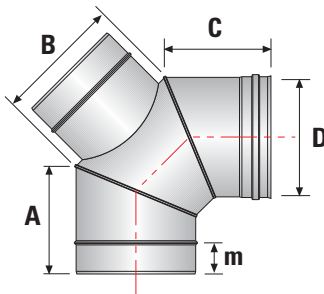

SLXDi90 90° İzleme Kapılı Dirsek

D	80	100	130	150	180	200	230	250	280	300	350	400	450	500	550	600
A	-	123	135	150	165	170	187	187	212	217	235	255	277	300	317	342
B	-	160	190	210	240	260	290	310	340	360	410	460	510	560	610	660
C	-	123	135	150	165	170	187	187	212	217	235	255	277	300	317	342
m	-	50	50	50	50	50	50	50	50	50	50	50	50	50	50	50

SLXT87 T Parçası 87°

D	80	100	130	150	180	200	230	250	280	300	350	400	450	500	550	600
H	200	283	350	350	350	350	450	450	450	450	550	550	650	650	700	950
B	105	135	150	160	175	185	200	210	225	235	270	295	320	345	395	420
m	50	50	50	50	50	50	50	50	50	50	50	50	50	50	50	50

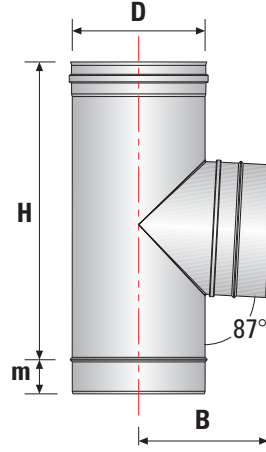

SLXT90 T Parçası 90°

D	80	100	130	150	180	200	230	250	280	300	350	400	450	500	550	600
H	200	283	350	350	350	350	450	450	450	450	550	550	650	650	700	950
B	105	135	150	160	175	185	200	210	225	235	270	295	320	345	395	420
m	50	50	50	50	50	50	50	50	50	50	50	50	50	50	50	50

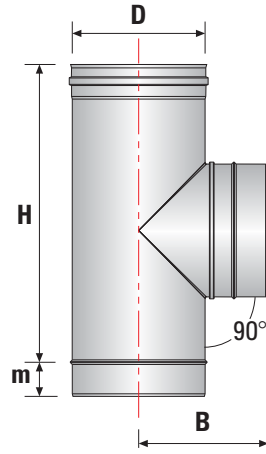

SLXT135 T Parçası 135°

D	80	100	130	150	180	200	230	250	280	300	350	400	450	500	550	600
H	-	283	283	350	450	450	550	550	-	650	650	950	950	950	999	1247
B	-	175	180	215	275	275	330	330	-	390	400	555	565	570	580	700
m	-	50	50	50	50	50	50	50	-	50	50	50	50	50	50	50

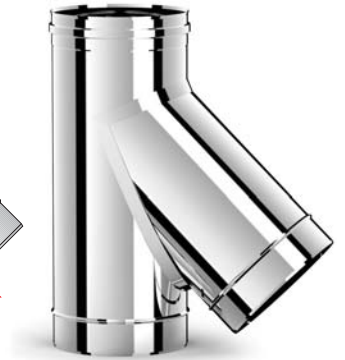
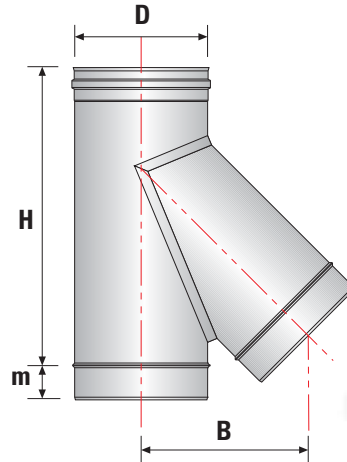

SLXKT90 Kaskat T Parçası 90°

D	80	100	130	150	180	200	230	250	280	300	350	400	450	500	550	600
H	-	200	200	200	200	200	200	200	200	200	200	200	200	200	200	200
C	100 - 130															
m	-	50	50	50	50	50	50	50	50	50	50	50	50	50	50	50

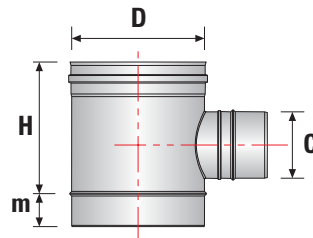

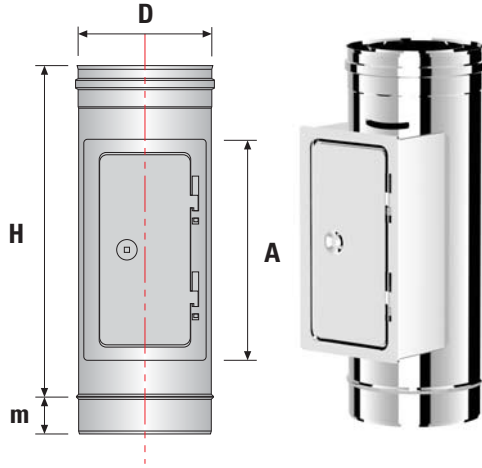

SLXTKB Temizleme Kapılı Boru

D	80	100	130	150	180	200	230	250	280	300	350	400	450	500	550	600
A	-	256	256	256	256	256	256	256	256	256	256	256	256	256	256	256
H	-	450	450	450	450	450	450	450	450	450	450	450	450	450	450	450
m	-	50	50	50	50	50	50	50	50	50	50	50	50	50	50	50

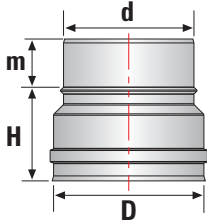

SLXR Redüksiyon - Adaptor

D	80	100	130	150	180	200	230	250	280	300	350	400	450	500	550	600
H	120	120	120	120	120	120	120	120	120	120	120	120	120	120	120	120
m	50	50	50	50	50	50	50	50	50	50	50	50	50	50	50	50

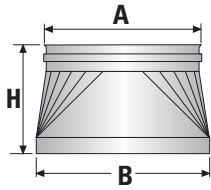

SLXKR Kare Redüksiyon

D	80	100	130	150	180	200	230	250	280	300	350	400	450	500	550	600
H	-	-	-	-	-	-	-	-	-	-	-	-	-	-	-	-
B X B	-	-	-	-	-	-	-	-	-	-	-	-	-	-	-	-

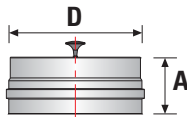

SLXDTK Dairesel Temizleme Kapağı

D	80	100	130	150	180	200	230	250	280	300	350	400	450	500	550	600
A	80	80	80	80	80	80	80	80	80	80	80	80	80	80	80	80

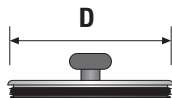

SLXCDTK Contalı Kapak

D	80	100	130	150	180	200	230	250	280	300	350	400	450	500	550	600
A	-	107	137	157	187	207	237	257	287	307	357	407	457	507	557	607

SLXYT Yoğuşma Toplayıcısı

D	80	100	130	150	180	200	230	250	280	300	350	400	450	500	550	600
A	80	80	80	80	80	80	80	80	80	80	80	80	80	80	80	80

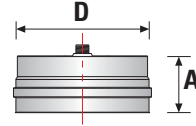

SLXYT Yatay Yoğuşma Toplayıcısı

D	80	100	130	150	180	200	230	250	280	300	350	400	450	500	550	600
A	130	130	130	130	130	130	130	130	130	130	130	130	130	130	130	130

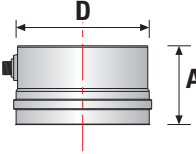

SLXOB250 2" Çatı Ölçüm Boru 250mm

D	80	100	130	150	180	200	230	250	280	300	350	400	450	500	550	600
H	-	200	200	200	200	200	200	200	200	200	200	200	200	200	200	200
C	-	100														
m	-	50	50	50	50	50	50	50	50	50	50	50	50	50	50	50

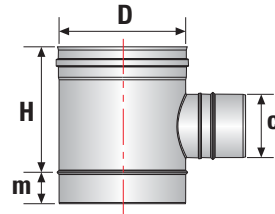

SLXOB250 Ölçüm Borusu 250 mm

D	80	100	130	150	180	200	230	250	280	300	350	400	450	500	550	600
H	200															
m	50	50	50	50	50	50	50	50	50	50	50	50	50	50	50	50

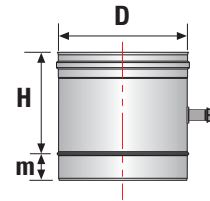

SLXOB500 Ölçüm Borusu 500 mm

D	80	100	130	150	180	200	230	250	280	300	350	400	450	500	550	600
H	450															
m	50	50	50	50	50	50	50	50	50	50	50	50	50	50	50	50

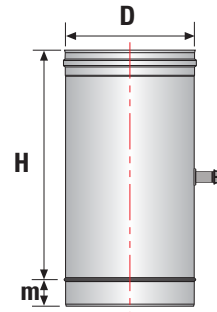

SLXOB1000 Ölçüm Borusu 1000 mm

D	80	100	130	150	180	200	230	250	280	300	350	400	450	500	550	600
H	950															
m	50	50	50	50	50	50	50	50	50	50	50	50	50	50	50	50

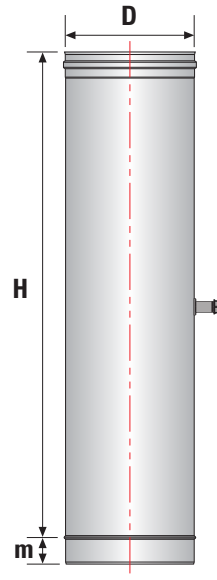

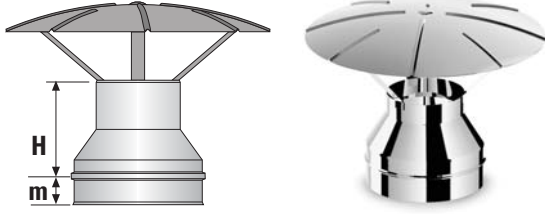

SLXYKS Yağmur Korumalı Şapka

D	80	100	130	150	180	200	230	250	280	300	350	400	450	500	550	600
H	120	120	120	120	120	120	120	120	120	120	120	120	120	120	120	120
m	50	50	50	50	50	50	50	50	50	50	50	50	50	50	50	50

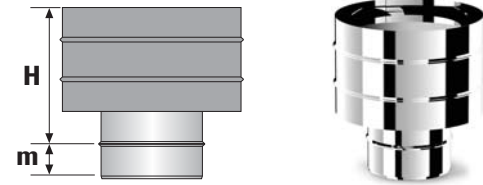

SLXRKS Rüzgar Korumalı Şapka

D	80	100	130	150	180	200	230	250	280	300	350	400	450	500	550	600
H	200	200	200	200	200	250	250	250	250	250	250	250	250	250	250	250
m	50	50	50	50	50	50	50	50	50	50	50	50	50	50	50	50

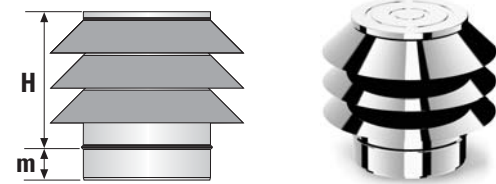

SLXRKSL Rüzgar Korumalı Şapka L

D	80	100	130	150	180	200	230	250	280	300	350	400	450	500	550	600
H	-	200	200	200	200	200	200	200	200	200	200	200	200	200	200	200
m	-	50	50	50	50	50	50	50	50	50	50	50	50	50	50	50

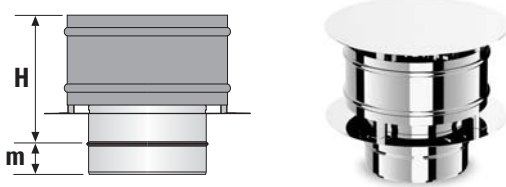

SLXRKSS Rüzgar Korumalı Şapka S

D	80	100	130	150	180	200	230	250	280	300	350	400	450	500	550	600
H	-	200	200	200	200	250	250	250	250	250	250	250	250	250	250	250
m	-	50	50	50	50	50	50	50	50	50	50	50	50	50	50	50

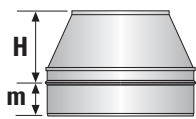

SLXKS Konus Şapka

D	80	100	130	150	180	200	230	250	280	300	350	400	450	500	550	600
H	140	140	140	140	140	140	140	140	140	170	170	170	170	170	170	170
m	50	50	50	50	50	50	50	50	50	50	50	50	50	50	50	50

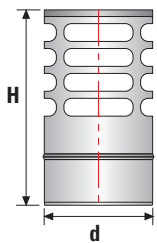

SLXRBS Radyant Baca Şapkası

D	80	100	130	-	-	-	-	-	-	-	-	-	-	-	-	-
H	200	200	200	-	-	-	-	-	-	-	-	-	-	-	-	-
m	50	50	50	-	-	-	-	-	-	-	-	-	-	-	-	-

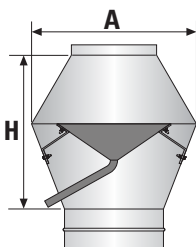

SLXJC Jet Cap

D	80	100	130	150	180	200	230	250	280	300	350	400	450	500	550	600
H	-	200	260	300	360	400	460	500	-	600	700	800	900	900	950	1000
A	-	175	225	260	315	350	400	440	-	525	600	650	700	750	800	850

SLXTT Temel Taşıyıcı

D	80	100	130	150	180	200	230	250	300	350	400	450	500	550	600
A	130	150	180	150	180	200	230	250	300	350	400	450	500	550	600
B	360	360	360	360	360	360	360	360	360	360	360	360	360	360	360

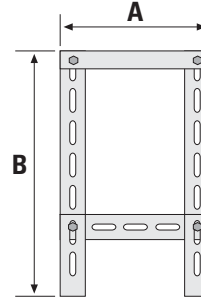

SLXBTS Borulu Taşıyıcı Sehpa

D	80	100	130	150	180	200	230	250	300	350	400	450	500	550	600
A	140	160	190	210	240	260	290	310	360	410	460	510	560	610	660
B	180	200	230	250	280	300	330	350	400	450	500	550	600	650	700
H	140	160	190	210	240	260	290	310	360	410	460	510	560	610	660

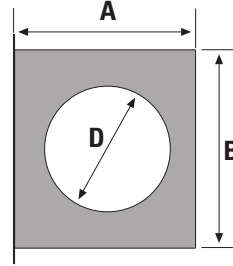
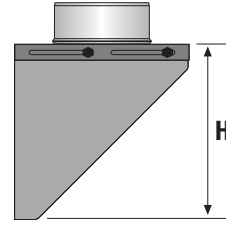

SLXKTS Kelepçeli Taşıyıcı Sehpa

D	80	100	130	150	180	200	230	250	300	350	400	450	500	550	600
A	150	170	200	220	250	270	300	320	370	420	470	520	570	620	670
B	180	200	230	250	280	300	330	350	400	450	500	550	600	650	700
H	150	170	200	220	250	270	300	320	370	420	470	520	570	620	670

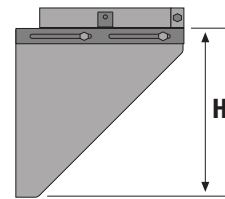
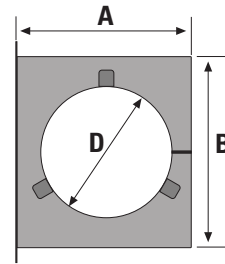

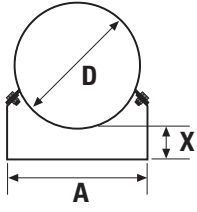

SLXDSKE Duvara Sabitleme Kelepçesi

D	80	100	130	150	180	200	230	250	280	300	350	400	450	500	550	600
A	105	130	160	175	205	225	255	276	280	300	329	380	430	480	508	536
X	55-75	60 mm														

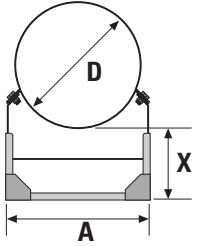

SLXDSKE11 Duvara Sabitleme Kelepçesi11

D	80	100	130	150	180	200	230	250	280	300	350	400	450	500	550	600
A	105	133	163	178	208	228	258	279	283	303	332	383	433	483	511	539
X	55-75	70 - 110 mm														

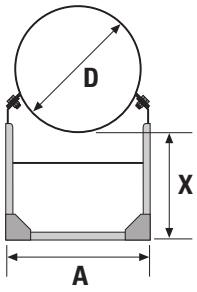

SLXDSKE21 Duvara Sabitleme Kelepçesi 21

D	80	100	130	150	180	200	230	250	280	300	350	400	450	500	550	600
A	-	133	163	178	208	228	258	279	-	-	-	-	-	-	-	-
X	-	120 - 210 mm														

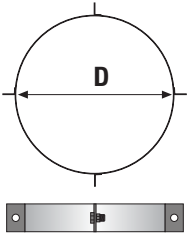

SLXGK Gerdirme Kelepçesi

D	80	100	130	150	180	200	230	250	280	300	350	400	450	500	550	600
---	----	-----	-----	-----	-----	-----	-----	-----	-----	-----	-----	-----	-----	-----	-----	-----

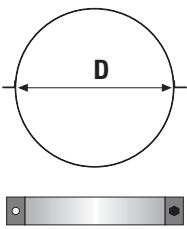

SLXAK Askı Kelepçesi

D	80	100	130	150	180	200	230	250	280	300	350	400	450	500	550	600
---	----	-----	-----	-----	-----	-----	-----	-----	-----	-----	-----	-----	-----	-----	-----	-----

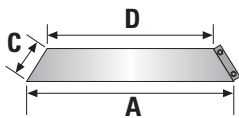

SLXCOB Çatı Örtü Bileziği

D	100	100	130	150	180	200	230	250	280	300	350	400	450	500	550	600	650
A	190	210	240	260	290	310	370	390	420	440	490	540	590	640	690	740	790
C	80	80	80	80	80	80	80	80	100	100	100	100	100	100	100	100	100

SLXHT Hilal Taşıyıcı

d	100	100	130	150	180	200	230	250	280	300	350	400	450	500	550	600
C	200 - 300 - 400 - 500 - 600 mm															

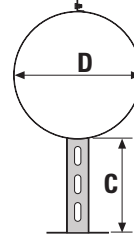

SLXHTU Hilal Taşıyıcı Uzun

D	80	100	130	150	180	200	230	250	280	300	350	400	450	500	550	600
C	610 - 1000 mm															

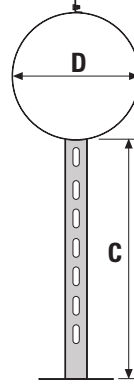

SLXBK Birleştirme Kelepçesi

D	80	100	130	150	180	200	230	250	280	300	350	400	450	500	550	600
A	47 mm															

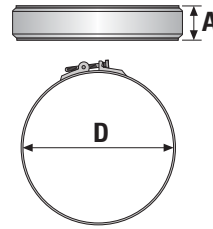

SLXBKİ Birleştirme Kelepçesi İnce

D	80	100	130	150	180	200	230	250	300	350	400	450	500	550	600	
A	17 mm															

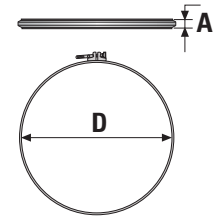

SLXBKT Birleştirme Kelepçesi Taşıyıcı

D	80	100	130	150	180	200	230	250	280	300	350	400	450	500	550	600
A	200 mm															

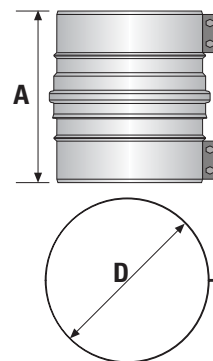

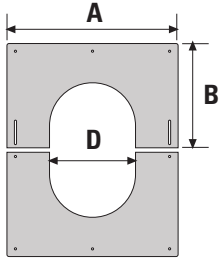

SLXDK30 Duvar Kapağı 30

D	80	100	130	150	180	200	230	250	280	300	350	400	450	500	550	600	650
A	280	300	330	350	380	400	430	450	480	500	550	600	650	-	-	-	-
B	145	160	175	190	205	220	235	250	265	280	310	335	360	-	-	-	-

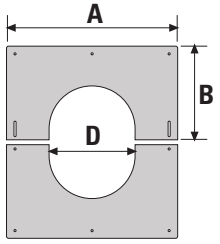

SLXDK45 Duvar Kapağı 45

D	80	100	130	150	180	200	230	250	280	300	350	400	450	500	550	600	650
A	280	300	330	350	380	400	430	450	480	500	550	600	650	-	-	-	-
B	155	175	195	210	230	245	270	280	300	320	350	410	460	-	-	-	-

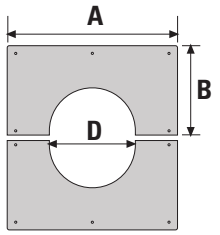

SLXDK90 Duvar Kapağı 90

D	80	100	130	150	180	200	230	250	280	300	350	400	450	500	550	600	650
A	280	300	330	350	380	400	430	450	480	500	550	600	650	-	-	-	-
B	140	160	175	185	200	210	225	235	250	260	285	310	335	-	-	-	-

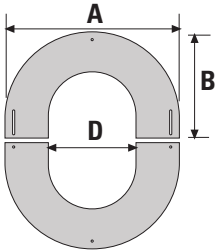

SLXOK30 Oval Duvar Kapağı 30

D	80	100	130	150	180	200	230	250	280	300	350	400	450	500	550	600	650
A	280	300	330	350	380	400	430	450	480	500	550	600	650	-	-	-	-
B	150	170	185	198	215	227	244	255	273	285	313	340	370	-	-	-	-

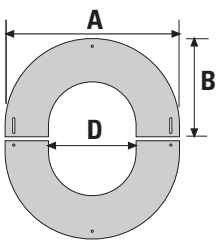

SLXOK45 Oval Duvar Kapağı 45

D	80	100	130	150	180	200	230	250	280	300	350	400	450	500	550	600	650
A	280	300	330	350	380	400	430	450	480	500	550	600	650	-	-	-	-
B	175	190	205	218	239	253	274	288	310	324	359	385	420	-	-	-	-

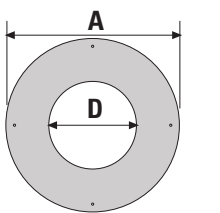

SLXOK90 Oval Duvar Kapağı 90

D	80	100	130	150	180	200	230	250	280	300	350	400	450	500	550	600	650
A	280	300	330	350	380	400	430	450	480	500	550	600	650	-	-	-	-

SLXHK Ahtapot Kelepçe

d	80	100	130	150	180	200	230	250	280	300	350	400	450	500	550	600
---	----	-----	-----	-----	-----	-----	-----	-----	-----	-----	-----	-----	-----	-----	-----	-----

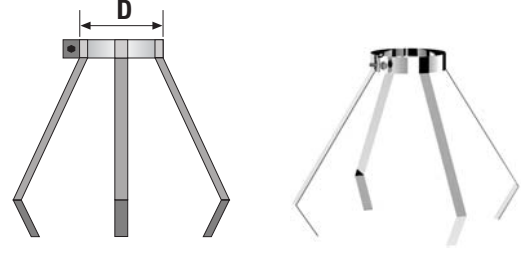

SLXC030 Çatı Örtüsü Kaplama 30

D	80	100	130	150	180	200	230	250	280	300	350	400	450	500	550	600	650
A	-	550	580	600	630	660	690	710	740	770	820	880	930	980	-	-	-
B	-	530	560	580	610	640	670	690	720	750	800	860	910	960	-	-	-
H	-	150	150	150	150	150	150	150	150	150	150	150	150	150	-	-	-
C	-	130	160	195	230	255	290	310	345	370	425	485	540	600	-	-	-

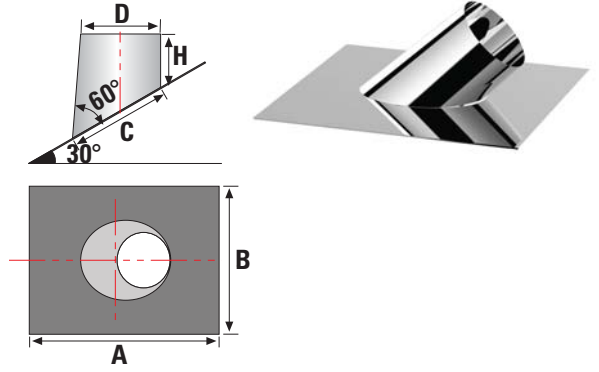

SLXC045 Çatı Örtüsü Kaplama 45

D	80	100	130	150	180	200	230	250	280	300	350	400	450	500	550	600	650
A	-	555	595	640	680	710	750	780	825	850	920	960	1000	1100	-	-	-
B	-	535	575	620	660	690	730	760	805	830	900	940	980	1080	-	-	-
H	-	150	150	150	150	150	150	150	150	150	150	150	150	150	-	-	-
C	-	155	195	240	280	310	350	380	425	450	520	590	665	735	-	-	-

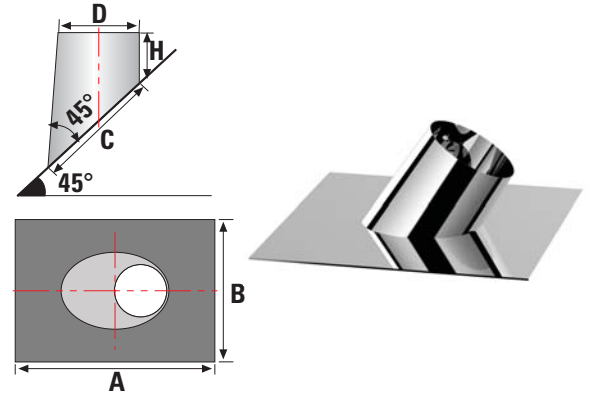

SLXC090 Çatı Örtüsü Kaplama 90

D	80	100	130	150	180	200	230	250	280	300	350	400	450	500	550	600	650
A	-	560	590	610	640	660	690	710	740	760	810	860	910	960	-	-	-
B	-	560	590	610	640	660	690	710	740	760	810	860	910	960	-	-	-
H	-	150	150	150	150	150	150	150	150	150	150	150	150	150	-	-	-
C	-	160	190	210	240	260	290	310	340	360	410	460	510	560	-	-	-

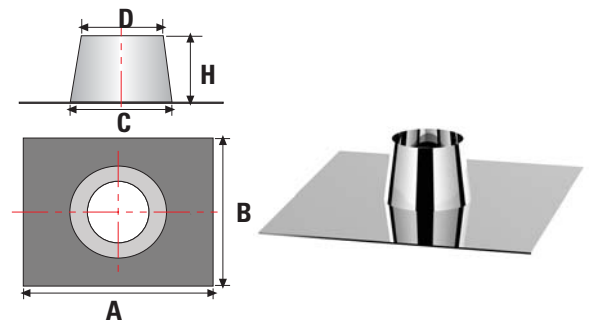

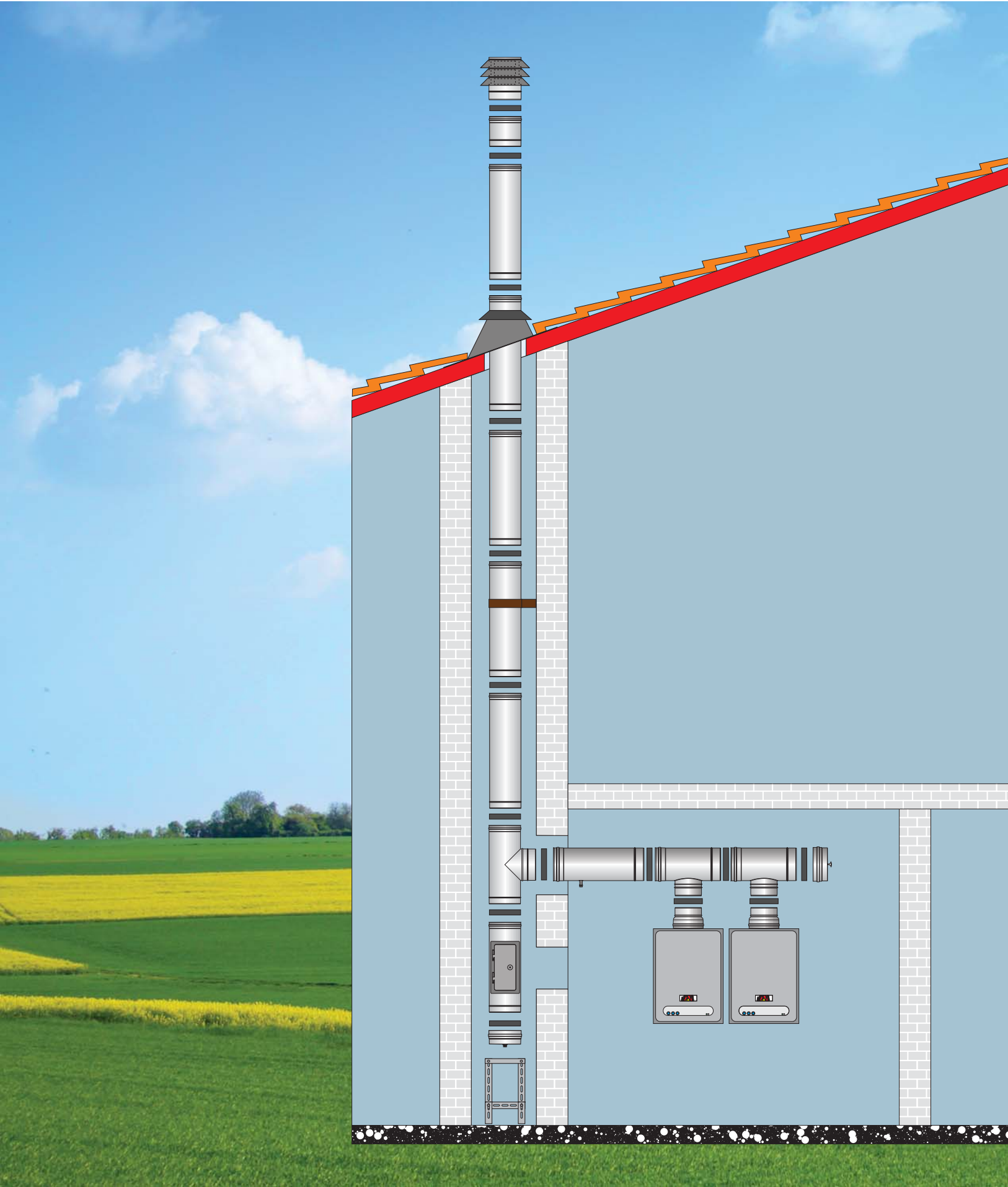

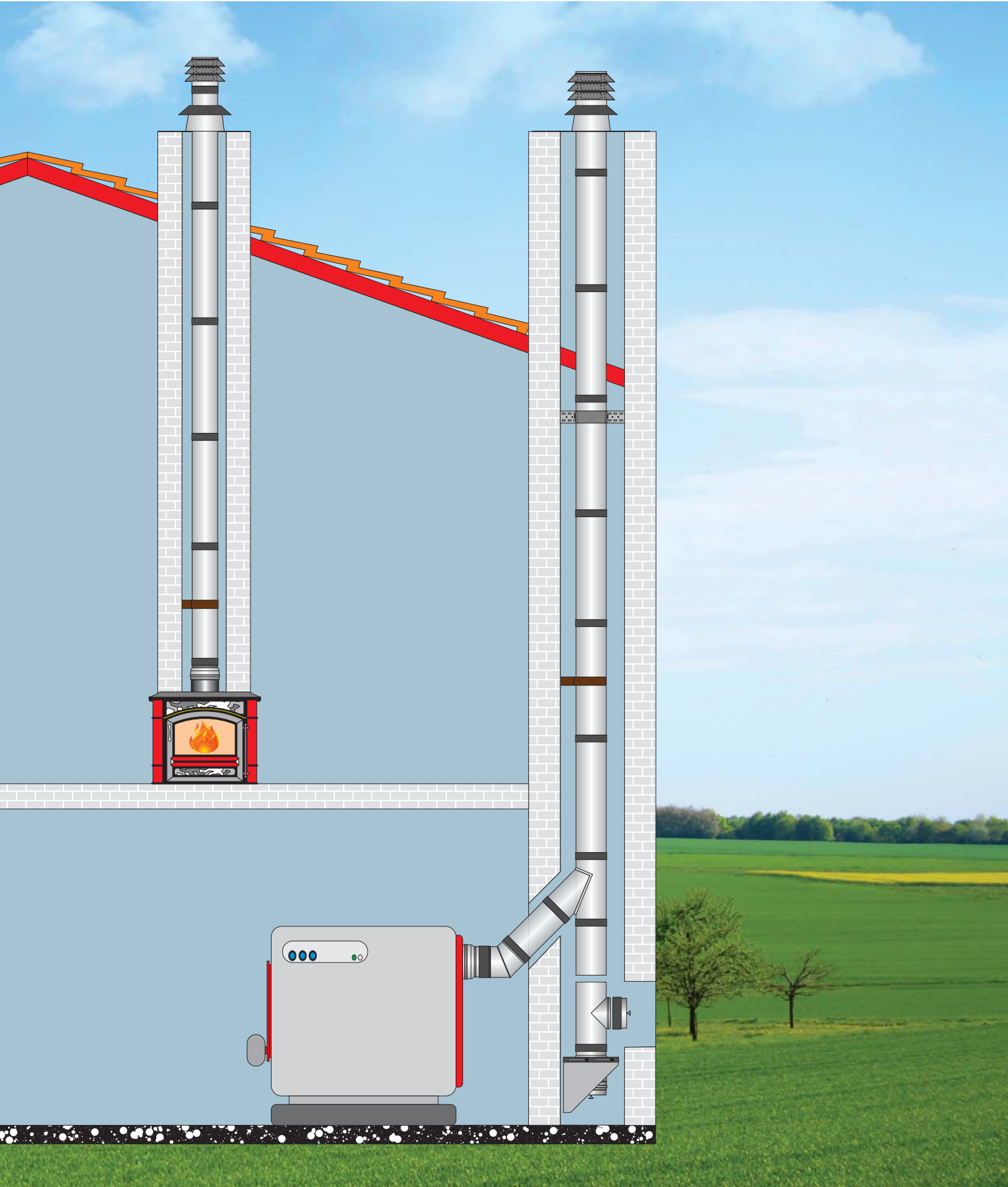

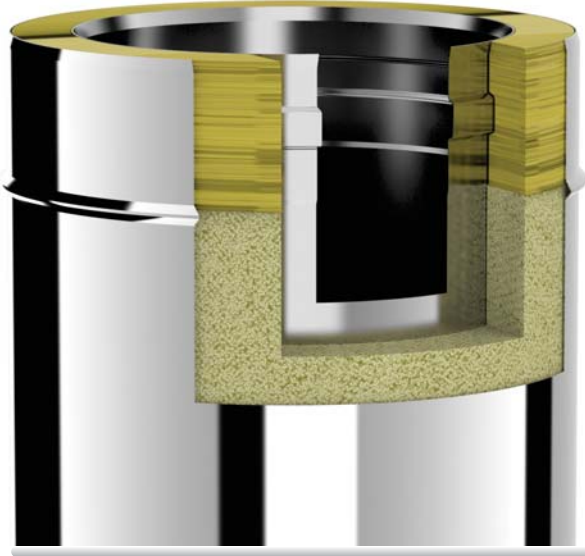

TEMEL ÖZELLİKLER

- Kolay ve hızlı kurulum.
- Bina içi ve bina dışı uygulamalar için uygundur.
- Yüksek yoğunluklu taşıyıcı yalıtımı.

- Muf : 50 mm.
- Kaynak Türü : Sürekli TIG Kaynağı.
- Kalınlık : 0.40 mm – 1.50 mm.
- Bağlantı Tipi : Erkek / Dişi Bağlantılar.
- Çap Aralığı : Ø 80 mm'den 1200 mm'ye Kadar.

TEKNİK ÖZELLİKLER

- Çalışma türü : Islak (W) (contalı kullanım)
Kuru (D) (contasız kullanım)
- Basınç türü : Pozitif (P1) (contalı kullanım)
Negatif (N1) (contasız kullanım)
- Max. çalışma basıncı : 200 Pa
- Çalışma sıcaklığı : 200 °C
600°C
- Malzeme : AISI 316L (1.4404)
AISI 304 (1.4301)
- Yakıt tipi : Doğalgaz / Katı yakıt / Sıvı yakıt

UYGULAMA ALANLARI

- Merkezi ısıtma ve sıcak su sistemleri
- Endüstriyel ve ticari baca sistemleri
- Ekmek fırınları
- Şömineler

SERTİFİKALAR

T200-P1-W-V2-L50 (040-150)-O100÷O600
T400-N1-W-V2-L50 (040-150)-O100÷O400
T400-N1-D- V2-L50 (040-150)-G100÷G400
T600-N1-D- V2-L50 (040-150)-G50
T600-N1-D-Vm-L20 (040-150)-G100



1020

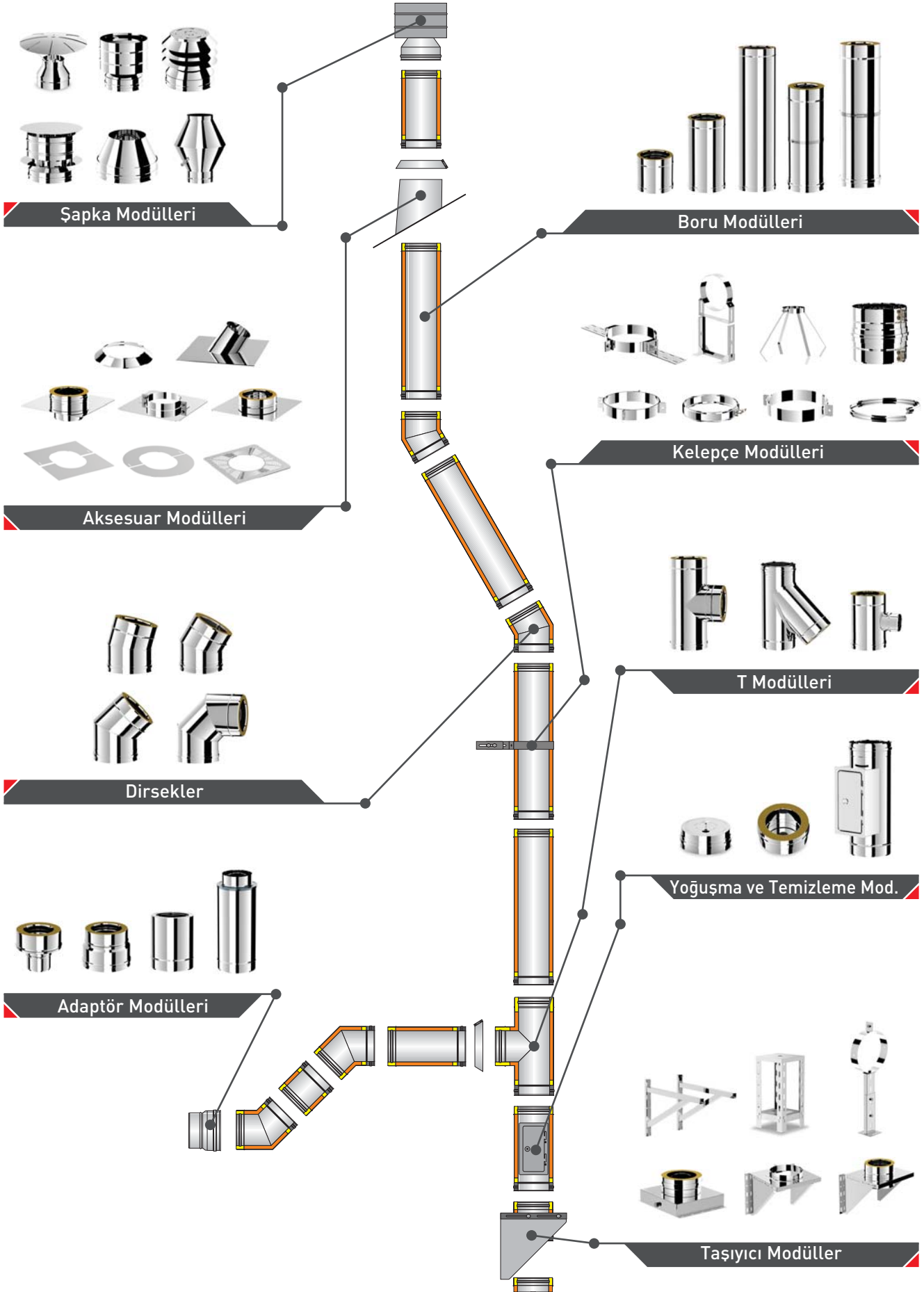

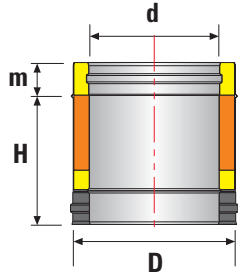

SLXAB250 Düz Boru 250 mm

d	80	100	130	150	180	200	230	250	300	350	400	450	500	550	600
D	130	150	180	200	230	250	280	300	350	400	450	500	550	600	650
H	200	200	200	200	200	200	200	200	200	200	200	200	200	200	200
m	50	50	50	50	50	50	50	50	50	50	50	50	50	50	50

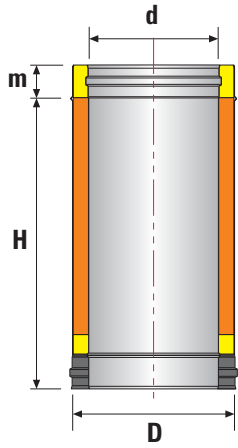

SLXAB500 Düz Boru 500 mm

d	80	100	130	150	180	200	230	250	300	350	400	450	500	550	600
D	130	150	180	200	230	250	280	300	350	400	450	500	550	600	650
H	450	450	450	450	450	450	450	450	450	450	450	450	450	450	450
m	50	50	50	50	50	50	50	50	50	50	50	50	50	50	50

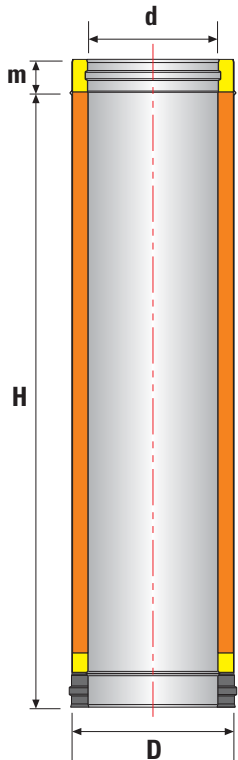

SLXAB100 Düz Boru 1000 mm

d	80	100	130	150	180	200	230	250	300	350	400	450	500	550	600
D	130	150	180	200	230	250	280	300	350	400	450	500	550	600	650
H	950	950	950	950	950	950	950	950	950	950	950	950	950	950	950
m	50	50	50	50	50	50	50	50	50	50	50	50	50	50	50

SLXAUB47 Teleskopik Boru 270-470 mm

d	80	100	130	150	180	200	230	250	300	350	400	450	500	550	600
D	130	150	180	200	230	250	280	300	350	400	450	500	550	600	650
Min	240	240	240	240	240	240	240	240	240	240	240	240	240	240	240
Max	420	420	420	420	420	420	420	420	420	420	420	420	420	420	420
m	50	50	50	50	50	50	50	50	50	50	50	50	50	50	50

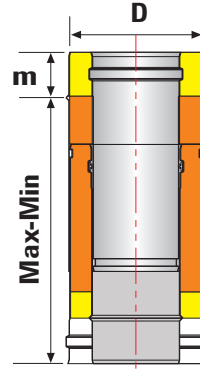

SLXAUB90 Teleskobik Boru 550-900 mm

d	80	100	130	150	180	200	230	250	300	350	400	450	500	550	600
D	130	150	180	200	230	250	280	300	350	400	450	500	550	600	650
Min	490	490	490	490	490	490	490	490	490	490	490	490	490	490	490
Max	920	920	920	920	920	920	920	920	920	920	920	920	920	920	920
m	50	50	50	50	50	50	50	50	50	50	50	50	50	50	50

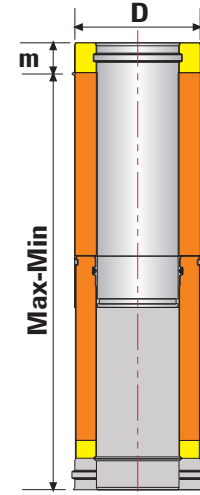

SLXABB500 Başlangıç Borusu 500 mm

d	80	100	130	150	180	200	230	250	300	350	400	450	500	550	600
D	130	150	180	200	230	250	280	300	350	400	450	500	550	600	650
H	450	450	450	450	450	450	450	450	450	-	-	-	-	-	-
m	50	50	50	50	50	50	50	50	50	-	-	-	-	-	-

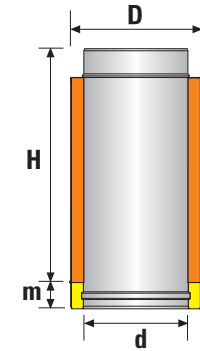

SLXABB1000 Başlangıç Borusu 1000 mm

d	80	100	130	150	180	200	230	250	300	350	400	450	500	550	600
D	130	150	180	200	230	250	280	300	350	400	450	500	550	600	650
H	950	950	950	950	950	950	950	950	950	-	-	-	-	-	-
m	50	50	50	50	50	50	50	50	50	-	-	-	-	-	-

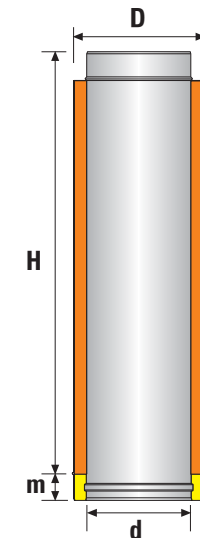

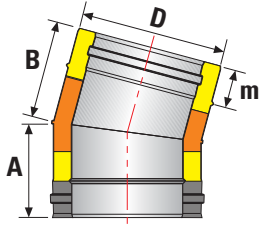

SLXAD15 Dirsek 15°

d	80	100	130	150	180	200	230	250	300	350	400	450	500	550	600
D	130	150	180	200	230	250	280	300	350	400	450	500	550	600	650
A	110	114	116	118	120	121	123	136	140	143	146	157	161	164	167
B	110	114	116	118	120	121	123	136	140	143	146	157	161	164	167
m	50	50	50	50	50	50	50	50	50	50	50	50	50	50	50

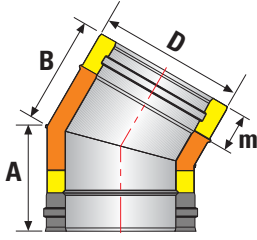

SLXAD30 Dirsek 30°

d	80	100	130	150	180	200	230	250	300	350	400	450	500	550	600
D	130	150	180	200	230	250	280	300	350	400	450	500	550	600	650
A	117	125	140	143	148	150	165	170	189	195	215	222	243	250	269
B	117	125	140	143	148	150	165	170	189	195	215	222	243	250	269
m	50	50	50	50	50	50	50	50	50	50	50	50	50	50	50

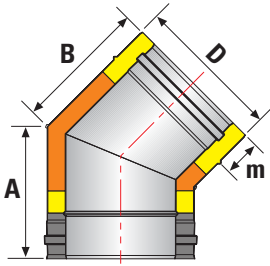

SLXAD45 Dirsek 45°

d	80	100	130	150	180	200	230	250	300	350	400	450	500	550	600
D	130	150	180	200	230	250	280	300	350	400	450	500	550	600	650
A	138	148	167	170	190	194	200	217	227	253	275	303	319	344	384
B	138	148	167	170	190	194	200	217	227	253	275	303	319	344	384
m	50	50	50	50	50	50	50	50	50	50	50	50	50	50	50

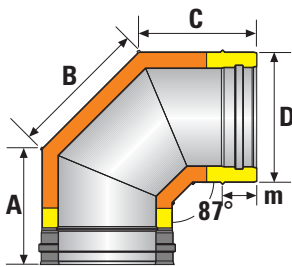

SLXAD87 Dirsek 87°

d	80	100	130	150	180	200	230	250	300	350	400	450	500	550	600
D	130	150	180	200	230	250	280	300	350	400	450	500	550	600	650
A	123	133	147	160	177	178	198	198	228	246	265	287	312	327	352
B	146	168	194	210	235	250	275	292	333	374	417	459	500	540	583
C	123	133	147	160	177	178	198	198	228	246	265	287	312	327	352
m	50	50	50	50	50	50	50	50	50	50	50	50	50	50	50

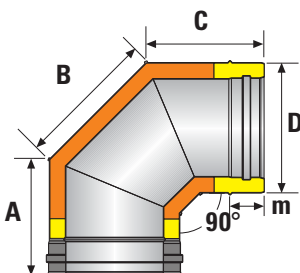

SLXAD90 Dirsek 90°

d	80	100	130	150	180	200	230	250	300	350	400	450	500	550	600
D	130	150	180	200	230	250	280	300	350	400	450	500	550	600	650
A	123	133	147	160	177	178	198	198	228	246	265	287	312	327	352
B	146	168	194	210	235	250	275	292	333	374	417	459	500	540	583
C	123	133	147	160	177	178	198	198	228	246	265	287	312	327	352
m	50	50	50	50	50	50	50	50	50	50	50	50	50	50	50

SLXAT87 T Parçası 87°

d	80	100	130	150	180	200	230	250	300	350	400	450	500	550	600
D	130	150	180	200	230	250	280	300	350	400	450	500	550	600	650
H	283	350	350	450	450	450	450	450	550	550	650	700	700	950	950
B	150	160	175	185	200	210	225	235	260	295	320	345	370	420	445
m	50	50	50	50	50	50	50	50	50	50	50	50	50	50	50

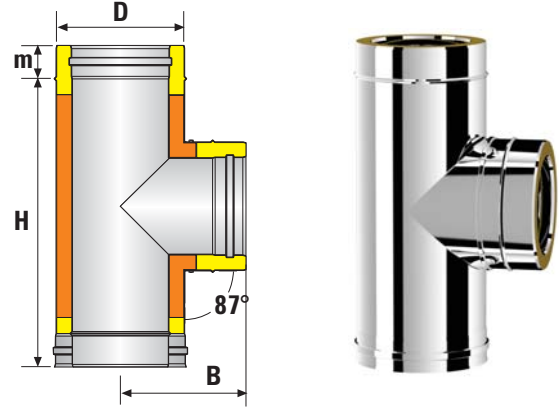

SLXAT90 T Parçası 90°

d	80	100	130	150	180	200	230	250	300	350	400	450	500	550	600
D	130	150	180	200	230	250	280	300	350	400	450	500	550	600	650
H	283	350	350	450	450	450	450	450	550	550	650	700	700	950	950
B	150	160	175	185	200	210	225	235	260	295	320	345	370	420	445
m	50	50	50	50	50	50	50	50	50	50	50	50	50	50	50

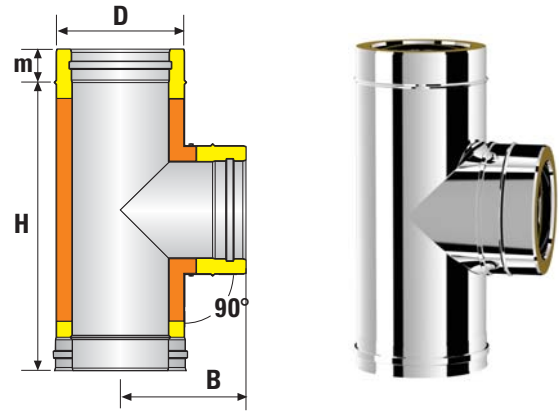

SLXAT135 T Parçası 135°

d	80	100	130	150	180	200	230	250	300	350	400	450	500	550	600
D	130	150	180	200	230	250	280	300	350	400	450	500	550	600	650
H	-	350	450	450	550	550	550	650	650	950	950	950	950	1200	1200
B	-	210	265	270	325	325	335	385	390	550	555	565	580	705	705
m	-	50	50	50	50	50	50	50	50	50	50	50	50	50	50

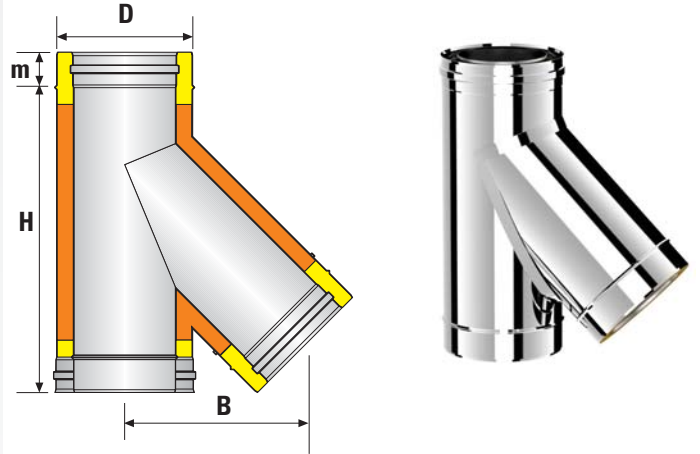

SLXAT135L T Parçası 135° Uzun

d	80	100	130	150	180	200	-	-	-	-	-	-	-	-	-
D	130	150	180	200	230	250	-	-	-	-	-	-	-	-	-
H	-	350	450	450	550	550	-	-	-	-	-	-	-	-	-
m	-	50	50	50	50	50	-	-	-	-	-	-	-	-	-
B	-	870	900	920	950	970	-	-	-	-	-	-	-	-	-
E	-	720	720	720	720	720	-	-	-	-	-	-	-	-	-
G	-	510	510	510	510	510	-	-	-	-	-	-	-	-	-

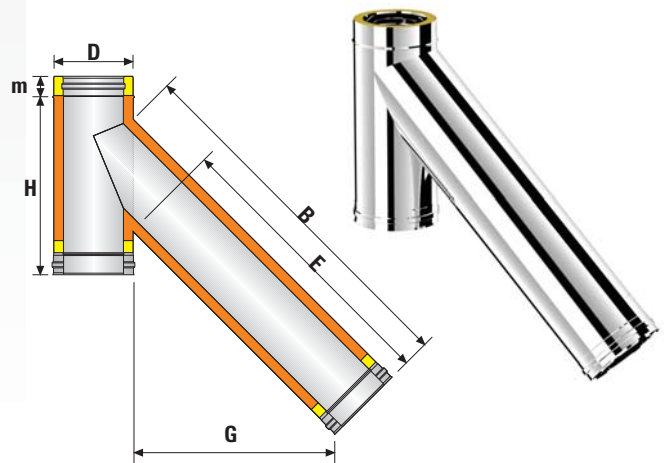

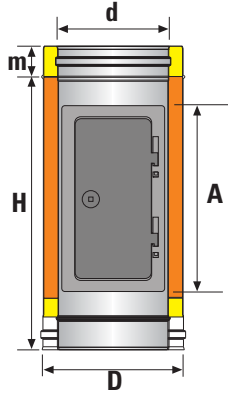

SLXATKB Temizleme Kapılı Boru

d	80	100	130	150	180	200	230	250	300	350	400	450	500	550	600
D	130	150	180	200	230	250	280	300	350	400	450	500	550	600	650
A	-	256	256	256	256	256	256	256	256	256	256	256	256	256	256
H	-	450	450	450	450	450	450	450	450	450	450	450	450	450	450
m	-	50	50	50	50	50	50	50	50	50	50	50	50	50	50

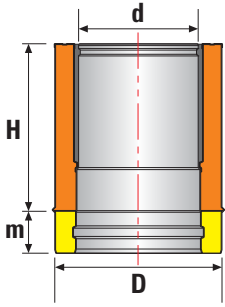

SLXANB Nisbus Modülü

d	80	100	130	150	180	200	230	250	300	350	400	450	500	550	600
D	130	150	180	200	230	250	280	300	350	400	450	500	550	600	650
H	-	200	200	200	200	200	200	200	200	200	200	200	200	200	200
m	-	50	50	50	50	50	50	50	50	50	50	50	50	50	50

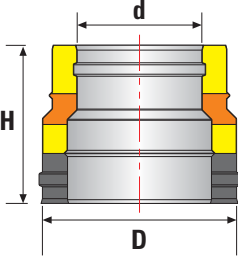

SLXACCR Redüksiyon Parçası

d	80	100	130	150	180	200	230	250	300	350	400	450	500	550	600
D	130	150	180	200	230	250	280	300	350	400	450	500	550	600	650
H	-	170	170	170	200	200	200	200	200	200	200	200	200	200	200
m	-	50	50	50	50	50	50	50	50	50	50	50	50	50	50

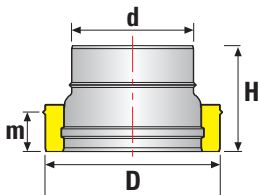

SLXATCR Tekten Çifte Redüksiyon

d	80	100	130	150	180	200	230	250	300	350	400	450	500	550	600
D	130	150	180	200	230	250	280	300	350	400	450	500	550	600	650
H	170	170	170	170	170	170	170	170	200	200	200	200	200	200	200
m	50	50	50	50	50	50	50	50	50	50	50	50	50	50	50

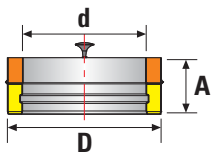

SLXADTK İzoleli Dairesel Temizleme Kapağı

d	80	100	130	150	180	200	230	250	300	350	400	450	500	550	600
D	130	150	180	200	230	250	280	300	350	400	450	500	550	600	650
A	80	80	80	80	80	80	80	80	80	80	80	80	80	80	80

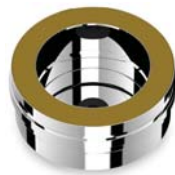
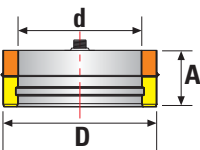

SLXAYT İzoleli Yoğuşma Toplayıcısı

d	80	100	130	150	180	200	230	250	300	350	400	450	500	550	600
D	130	150	180	200	230	250	280	300	350	400	450	500	550	600	650
A	80	80	80	80	80	80	80	80	80	80	80	80	80	80	80

SLXAOB250 Ölçüm Borusu 250 mm

d	80	100	130	150	180	200	230	250	300	350	400	450	500	550	600
D	130	150	180	200	230	250	280	300	350	400	450	500	550	600	650
H	200	200	200	200	200	200	200	200	200	200	200	200	200	200	200
m	50	50	50	50	50	50	50	50	50	50	50	50	50	50	50

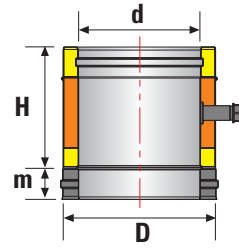

SLXAOB500 Ölçüm Borusu 500 mm

d	80	100	130	150	180	200	230	250	300	350	400	450	500	550	600
D	130	150	180	200	230	250	280	300	350	400	450	500	550	600	650
H	450	450	450	450	450	450	450	450	450	450	450	450	450	450	450
m	50	50	50	50	50	50	50	50	50	50	50	50	50	50	50

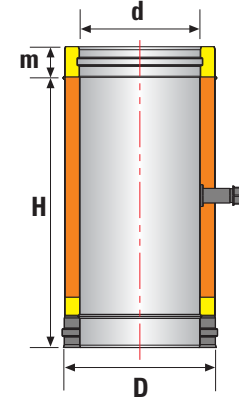

SLXAOB1000 Ölçüm Borusu 1000 mm

d	80	100	130	150	180	200	230	250	300	350	400	450	500	550	600
D	130	150	180	200	230	250	280	300	350	400	450	500	550	600	650
H	950	950	950	950	950	950	950	950	950	950	950	950	950	950	950
m	50	50	50	50	50	50	50	50	50	50	50	50	50	50	50

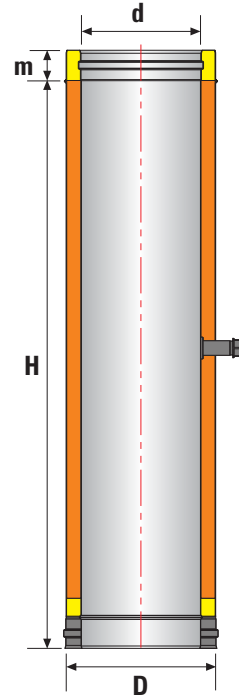

SLXACOB250 2" Çatı Ölçüm Borusu 250mm

d	100	130	150	180	200	230	250	300	350	400	450	500	550	600
D	150	180	200	230	250	280	300	350	400	450	500	550	600	650
H	200	200	200	200	200	200	200	200	200	200	200	200	200	200
C	100	100	100	100	100	100	100	100	100	100	100	100	100	100
M	50	50	50	50	50	50	50	50	50	50	50	50	50	50

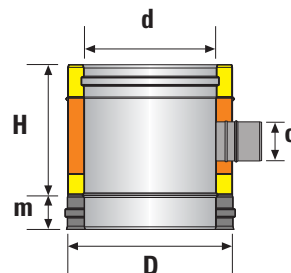

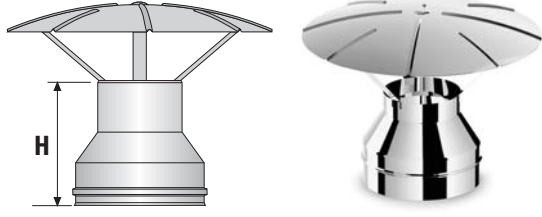

SLXAYKS Yağmur Korumalı Şapka

d	80	100	130	150	180	200	230	250	300	350	400	450	500	550	600
D	130	150	180	200	230	250	280	300	350	400	450	500	550	600	650
H	170	170	170	170	170	170	170	170	170	-	-	-	-	-	-

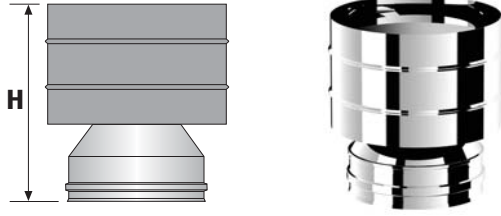

SLXARKS Rüzgar Korumalı Şapka

d	80	100	130	150	180	200	230	250	300	350	400	450	500	550	600
D	130	150	180	200	230	250	280	300	350	400	450	500	550	600	650
H	250	250	250	250	250	300	300	300	300	-	-	-	-	-	-

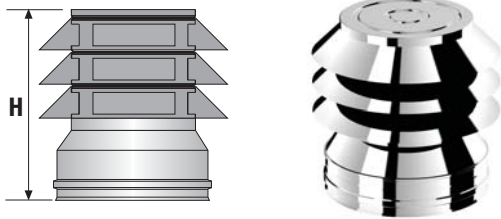

SLXARKSL Rüzgar Korumalı Şapka L

d	80	100	130	150	180	200	230	250	300	350	400	450	500	550	600
D	130	150	180	200	230	250	280	300	350	400	450	500	550	600	650
H	-	330	330	330	330	330	330	330	330	-	-	-	-	-	-

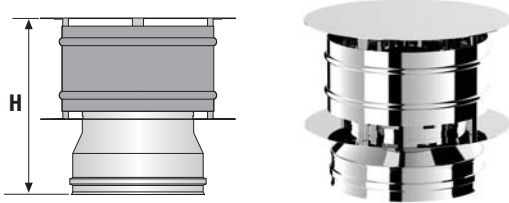

SLXARKSS Rüzgar Korumalı Şapka S

d	80	100	130	150	180	200	230	250	300	350	400	450	500	550	600
D	130	150	180	200	230	250	280	300	350	400	450	500	550	600	650
H	250	250	250	250	250	300	300	300	300	-	-	-	-	-	-

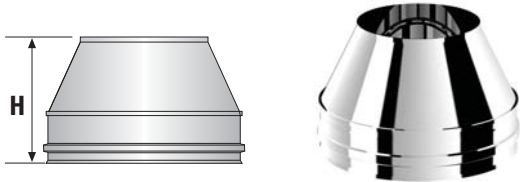

SLXAKS Konus Şapka

d	80	100	130	150	180	200	230	250	300	350	400	450	500	550	600
D	130	150	180	200	230	250	280	300	350	400	450	500	550	600	650
H	200	200	200	200	200	250	250	250	250	250	250	300	300	300	300

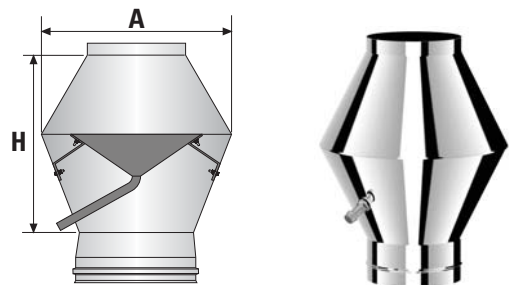

SLXAJC Jet Cap

d	80	100	130	150	180	200	230	250	300	350	400	450	500	550	600
D	130	150	180	200	230	250	280	300	350	400	450	500	550	600	650
H	-	300	360	400	460	500	550	600	700	800	900	900	950	1000	1050
A	-	260	315	350	400	440	480	525	600	650	700	750	800	850	900

SLXATT Temel Taşıyıcı

d	80	100	130	150	180	200	230	250	300	350	400	450	500	550	600
D	130	150	180	200	230	250	280	300	350	400	450	500	550	600	650
A	130	150	180	200	230	250	280	300	350	400	450	500	550	600	650
B	360	360	360	360	360	360	360	360	360	360	360	360	360	360	360

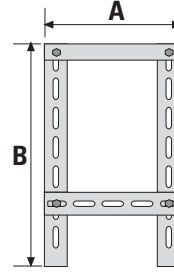

SLXABTS Borulu Taşıyıcı Sehpa

d	80	100	130	150	180	200	230	250	300	350	400	450	500	550	600
D	130	150	180	200	230	250	280	300	350	400	450	500	550	600	650
A	190	210	240	260	290	310	340	360	410	460	510	560	610	660	710
B	250	270	300	320	350	370	400	420	470	520	570	620	670	720	770
H	190	210	240	260	290	310	340	360	410	460	510	560	610	660	710

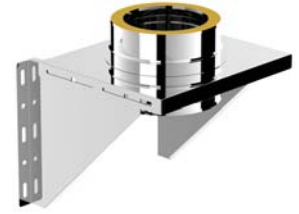
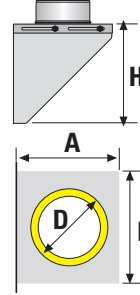

SLXAKTS Kelepçeli Taşıyıcı Sehpa

d	80	100	130	150	180	200	230	250	300	350	400	450	500	550	600
D	130	150	180	200	230	250	280	300	350	400	450	500	550	600	650
A	200	220	250	270	300	320	350	370	420	470	520	570	620	670	720
B	250	270	300	320	350	370	400	420	470	520	570	620	670	720	770
H	200	220	250	270	300	320	350	370	420	470	520	570	620	670	720

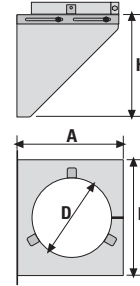

SLXATA20 Taşıyıcı Ayağı 20

d	80	100	130	150	180	200	230	250	300	350	400	450	500	550	600	
D	130	150	180	200	230	250	280	300	350	400	450	500	550	600	650	
A	-	320	320	320	335	335	-	350	364	378	-	-	-	-	-	
B	-	430	430	430	500	500	-	530	600	650	-	-	-	-	-	
X	-	50 - 200 mm														

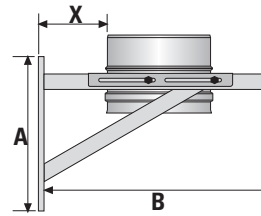

SLXATA30 Taşıyıcı Ayağı 30

d	80	100	130	150	180	200	230	250	300	350	400	450	500	550	600	
D	130	150	180	200	230	250	280	300	350	400	450	500	550	600	650	
A	-	378	378	378	393	393	-	407	420	436	-	-	-	-	-	
B	-	530	530	530	600	600	-	650	700	750	-	-	-	-	-	
X	-	50 - 300 mm														

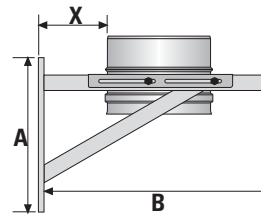

SLXATA40 Taşıyıcı Ayağı 40

d	80	100	130	150	180	200	230	250	300	350	400	450	500	550	600	
D	130	150	180	200	230	250	280	300	350	400	450	500	550	600	650	
A	-	436	436	436	450	450	-	465	480	494	-	-	-	-	-	
B	-	630	630	630	700	700	-	750	800	850	-	-	-	-	-	
X	-	50 - 400 mm														

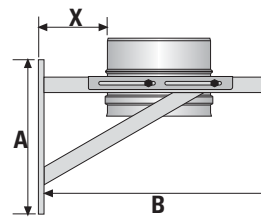

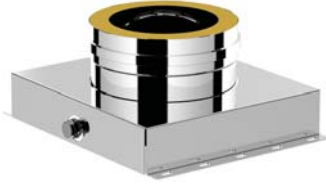
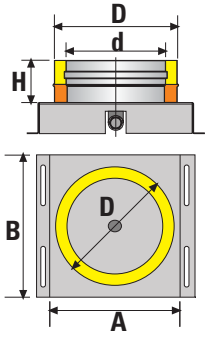

SLXAYTT Taşıyıcılı Yoğuşma Toplayıcısı

d	80	100	130	150	180	200	230	250	300	350	400	450	500	550	600
D	130	150	180	200	230	250	280	300	350	400	450	500	550	600	650
A	230	250	280	300	330	350	380	400	450	500	550	600	650	700	750
B	180	200	230	250	280	300	330	350	400	450	500	550	600	650	700
H	80 mm														

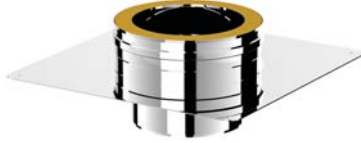
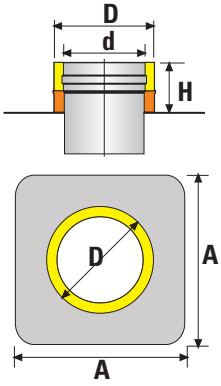

SLXAUD Üst Destek

d	80	100	130	150	180	200	230	250	300	350	400	450	500	550	600
D	130	150	180	200	230	250	280	300	350	400	450	500	550	600	650
A	320	340	370	390	420	440	470	490	540	590	-	-	-	-	-
A	320	340	370	390	420	440	470	490	540	590	-	-	-	-	-
H	70 mm														

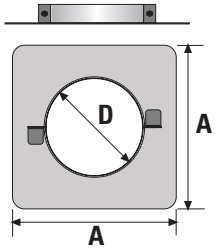

SLXAKD Kare Destek

d	80	100	130	150	180	200	230	250	300	350	400	450	500	550	600
D	130	150	180	200	230	250	280	300	350	400	450	500	550	600	650
A	320	340	370	390	420	440	470	490	540	590	-	-	-	-	-
A	320	340	370	390	420	440	470	490	540	590	-	-	-	-	-

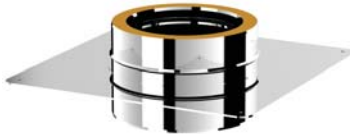
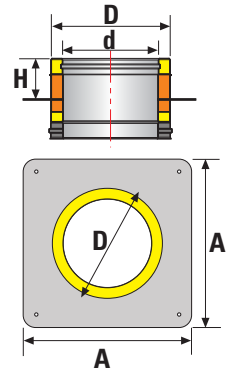

SLXAOD Orta Destek

d	80	100	130	150	180	200	230	250	300	350	400	450	500	550	600
D	130	150	180	200	230	250	280	300	350	400	450	500	550	600	650
A	320	340	370	390	420	440	470	490	540	590	-	-	-	-	-
A	320	340	370	390	420	440	470	490	540	590	-	-	-	-	-
H	70 mm														

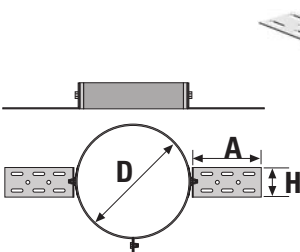

SLXAUK Üst Kelepçe

d	80	100	130	150	180	200	230	250	300	350	400	450	500	550	600
D130	150	180	200	230	250	280	300	350	400	450	500	550	600	650	
A	155 mm														
H	60 mm														

SLXADSK Duvara Sabitleme Kelepçesi

d	80	100	130	150	180	200	230	250	300	350	400	450	500	550	600
D	130	150	180	200	230	250	280	300	350	400	450	500	550	600	650
A	163	175	205	225	255	276	280	300	329	380	430	480	508	536	-
X	60 mm														

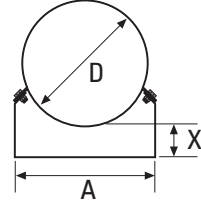

SLXADSK11 Duvara Sabitleme Kelepçesi 11

d	80	100	130	150	180	200	230	250	300	350	400	450	500	550	600
D	130	150	180	200	230	250	280	300	350	400	450	500	550	600	650
A	166	178	208	228	258	279	283	303	332	383	433	483	511	539	-
X	70 - 110 mm														

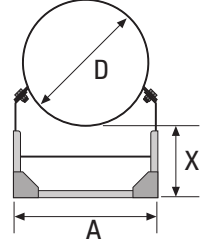

SLXADSK21 Duvara Sabitleme Kelepçesi 21

d	80	100	130	150	180	200	230	250	300	350	400	450	500	550	600
D	130	150	180	200	230	250	280	300	350	400	450	500	550	600	650
A	166	178	208	228	258	279	283	303	-	-	-	-	-	-	-
X	120 - 210 mm														

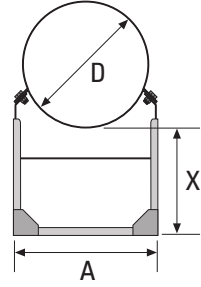

SLXAGK Gerdirme Kelepçesi

d	80	100	130	150	180	200	230	250	300	350	400	450	500	550	600
D	130	150	180	200	230	250	280	300	350	400	450	500	550	600	650

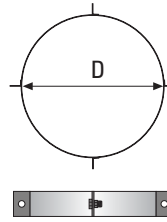

SLXAAK Askı Kelepçesi

d	80	100	130	150	180	200	230	250	300	350	400	450	500	550	600
D	130	150	180	200	230	250	280	300	350	400	450	500	550	600	650

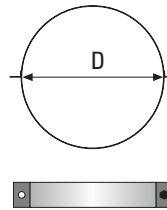

SLXACOB Çatı Örtü Bileziği

d	80	100	130	150	180	200	230	250	300	350	400	450	500	550	600
D	130	150	180	200	230	250	280	300	350	400	450	500	550	600	650
A	240	260	290	310	370	390	420	440	490	540	590	640	690	740	790
C	80	80	80	80	80	80	100	100	100	100	100	100	100	100	100

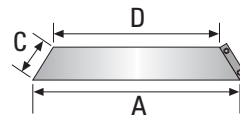

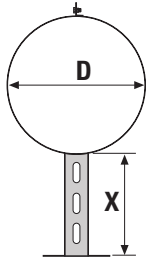

SLXAHT Hilal Taşıyıcı

d	80	100	130	150	180	200	230	250	300	350	400	450	500	550	600
D	130	150	180	200	230	250	280	300	350	400	450	500	550	600	650
C	200 - 300 - 400 - 500 - 600 mm														

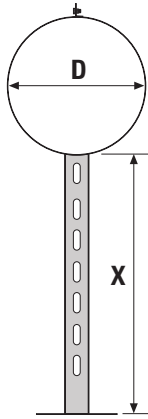

SLXAHTU Hilal Taşıyıcı Uzun

d	80	100	130	150	180	200	230	250	300	350	400	450	500	550	600
D	130	150	180	200	230	250	280	300	350	400	450	500	550	600	650
C	610 - 1000 mm														

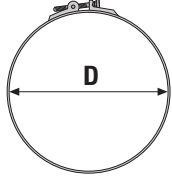

SLXABK Birleştirme Kelepçesi

d	80	100	130	150	180	200	230	250	300	350	400	450	500	550	600
D	130	150	180	200	230	250	280	300	350	400	450	500	550	600	650
A	47 mm														

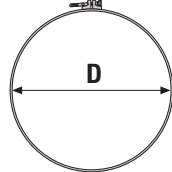

SLXABKİ Birleştirme Kelepçesi İnce

D	80	100	130	150	180	200	230	250	300	350	400	450	500	550	600
A	17 mm														

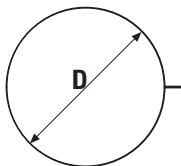
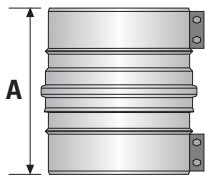

SLXABKT Birleştirme Kelepçesi Taşıyıcı

d	80	100	130	150	180	200	230	250	300	350	400	450	500	550	600
D	130	150	180	200	230	250	280	300	350	400	450	500	550	600	650
A	200 mm														

SLXADK30 Duvar Kapağı 30

d	80	100	130	150	180	200	230	250	300	350	400	450	500	550	600
D	130	150	180	200	230	250	280	300	350	400	450	500	550	600	650
A	330	350	380	400	430	450	480	500	550	600	650	-	-	-	-
B	175	190	205	220	235	250	265	280	310	335	360	-	-	-	-

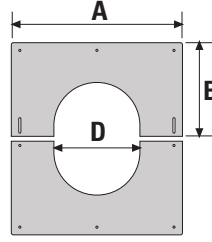

SLXADK45 Duvar Kapağı 45

d	80	100	130	150	180	200	230	250	300	350	400	450	500	550	600
D	130	150	180	200	230	250	280	300	350	400	450	500	550	600	650
A	330	350	380	400	430	450	480	500	550	600	650	-	-	-	-
B	195	210	230	245	270	280	300	320	350	410	460	-	-	-	-

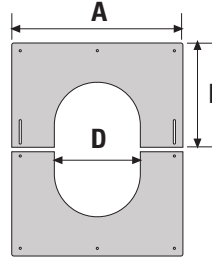

SLXADK90 Duvar Kapağı 90

d	80	100	130	150	180	200	230	250	300	350	400	450	500	550	600
D	130	150	180	200	230	250	280	300	350	400	450	500	550	600	650
A	330	350	380	400	430	450	480	500	550	600	650	-	-	-	-
B	175	185	200	210	225	235	250	260	285	310	335	-	-	-	-

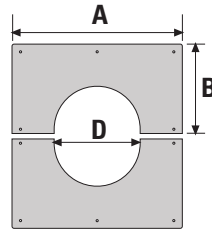

SLXAOK30 Oval Duvar Kapağı 30

d	80	100	130	150	180	200	230	250	300	350	400	450	500	550	600
D	130	150	180	200	230	250	280	300	350	400	450	500	550	600	650
A	330	350	380	400	430	450	480	500	550	600	650	-	-	-	-
B	185	198	215	227	244	255	273	285	313	340	370	-	-	-	-

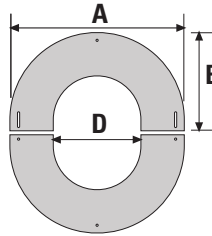

SLXAOK45 Oval Duvar Kapağı 45

d	80	100	130	150	180	200	230	250	300	350	400	450	500	550	600
D	130	150	180	200	230	250	280	300	350	400	450	500	550	600	650
A	330	350	380	400	430	450	480	500	550	600	650	-	-	-	-
B	205	218	239	253	274	288	310	324	359	385	420	-	-	-	-

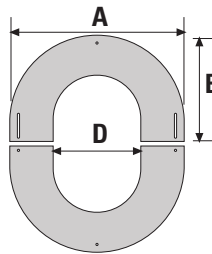

SLXAOK90 Oval Duvar Kapağı 90

d	8	100	130	150	180	200	230	250	300	350	400	450	500	550	600
D	130	150	180	200	230	250	280	300	350	400	450	500	550	600	650
A	330	350	380	400	430	450	480	500	550	600	650	-	-	-	-

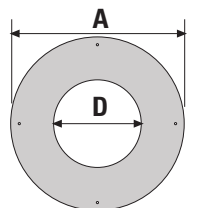

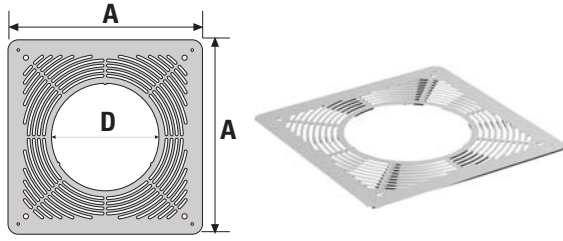

SLXAYKP Yangın Koruma Plakası

d	80	100	130	150	180	200	230	250	300	350	400	450	500	550	600
D	130	150	180	200	230	250	280	300	350	400	450	500	550	600	650
A	310	330	360	380	410	430	460	480	530	580	630	-	-	-	-
A	310	330	360	380	410	430	460	480	530	580	630	-	-	-	-

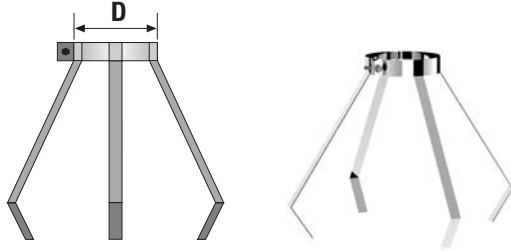

SLXAHK Ahtapot Keleçe

d	80	100	130	150	180	200	230	250	300	350	400	450	500	550	600
D	130	150	180	200	230	250	280	300	350	400	450	500	550	600	650

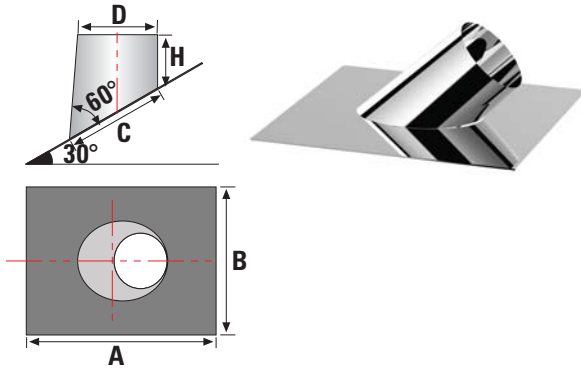

SLXAC030 Çatı Örtüsü Kaplama 30

d	80	100	130	150	180	200	230	250	300	350	400	450	500	550	600
D	130	150	180	200	230	250	280	300	350	400	450	500	550	600	650
A	580	600	630	660	690	710	740	770	820	880	930	980	-	-	-
B	530	580	610	640	670	690	720	750	800	860	910	960	-	-	-
H	150	150	150	150	150	150	150	150	150	150	150	150	-	-	-
C	130	195	230	255	290	310	345	370	425	485	540	600	-	-	-

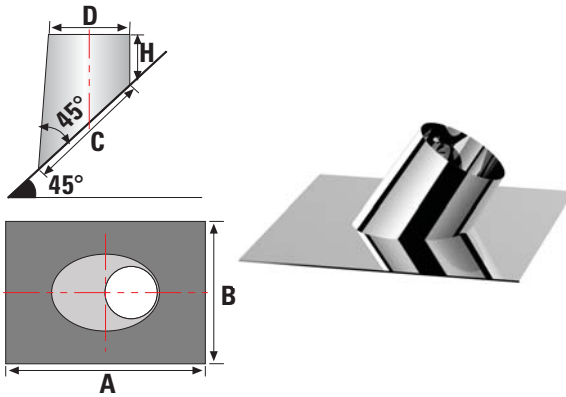

SLXAC045 Çatı Örtüsü Kaplama 45

d	80	100	130	150	180	200	230	250	300	350	400	450	500	550	600
D	130	150	180	200	230	250	280	300	350	400	450	500	550	600	650
A	595	640	680	710	750	780	825	850	920	960	1000	1100	-	-	-
B	575	620	660	690	730	760	805	830	900	940	980	1080	-	-	-
H	150	150	150	150	150	150	150	150	150	150	150	150	-	-	-
C	195	240	280	310	350	380	425	450	520	590	665	735	-	-	-

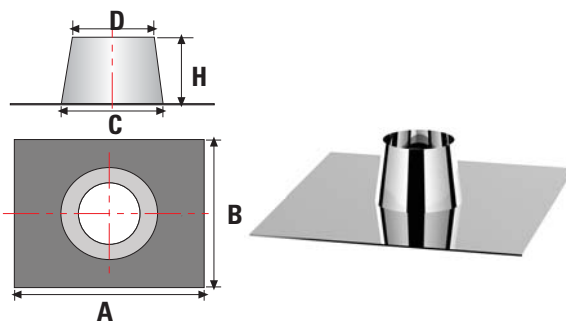

SLXAC090 Çatı Örtüsü Kaplama 90

d	80	100	130	150	180	200	230	250	300	350	400	450	500	550	600
D	130	150	180	200	230	250	280	300	350	400	450	500	550	600	650
A	590	610	640	660	690	710	740	760	810	860	910	960	-	-	-
B	590	610	640	660	690	710	740	760	810	860	910	960	-	-	-
H	150	150	150	150	150	150	150	150	150	150	150	150	-	-	-
C	190	210	240	260	290	310	340	360	410	460	510	560	-	-	-

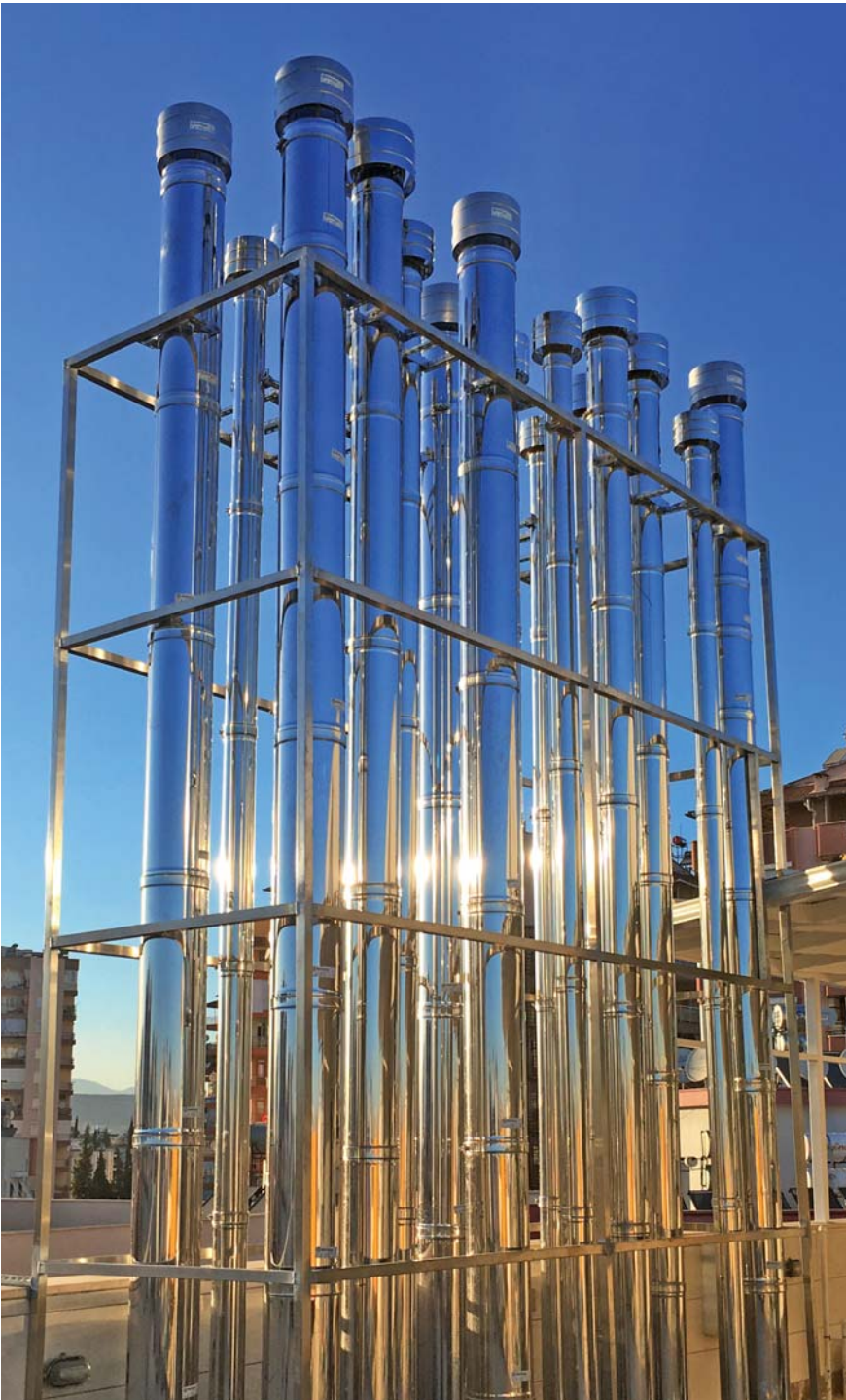

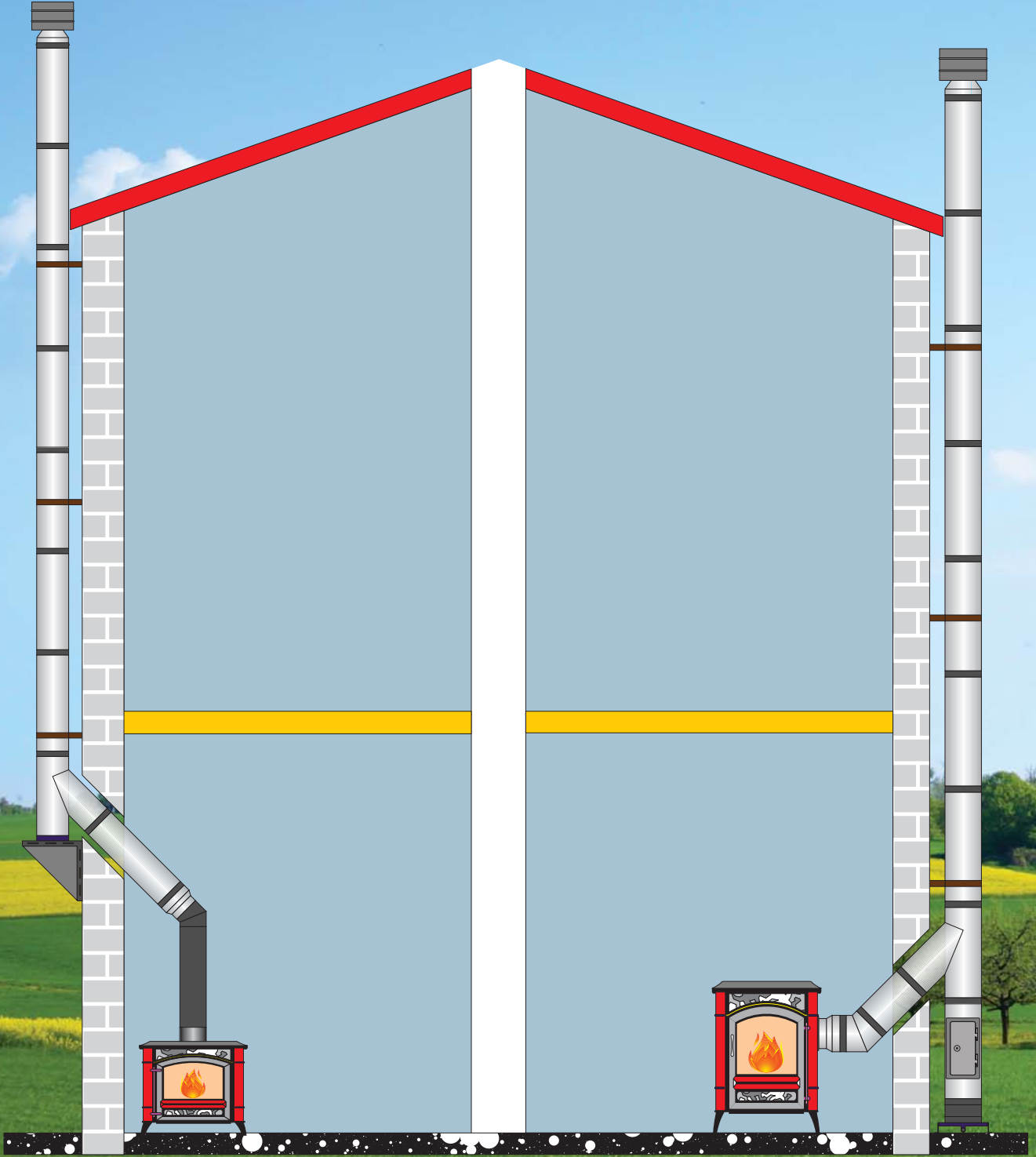

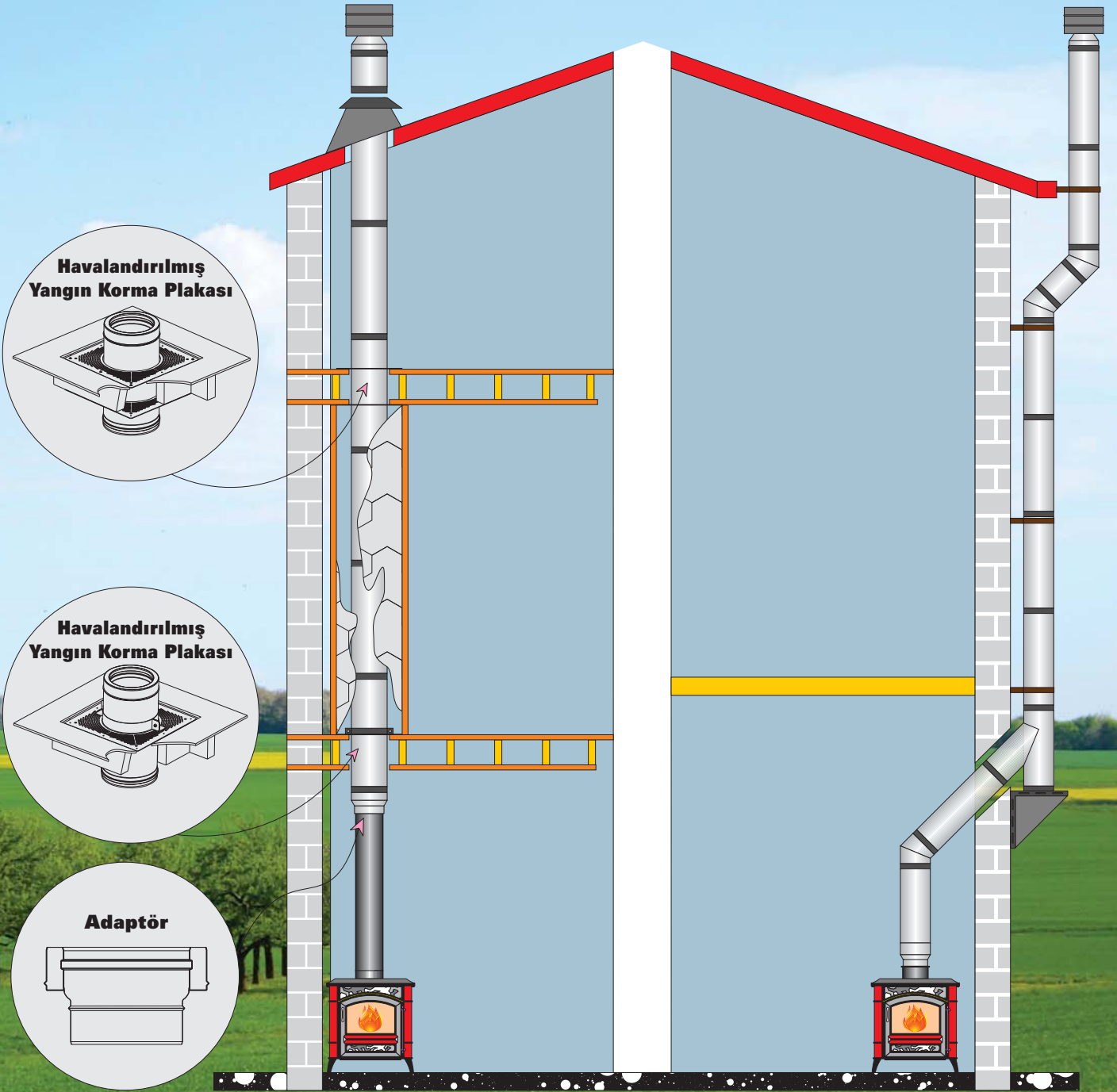

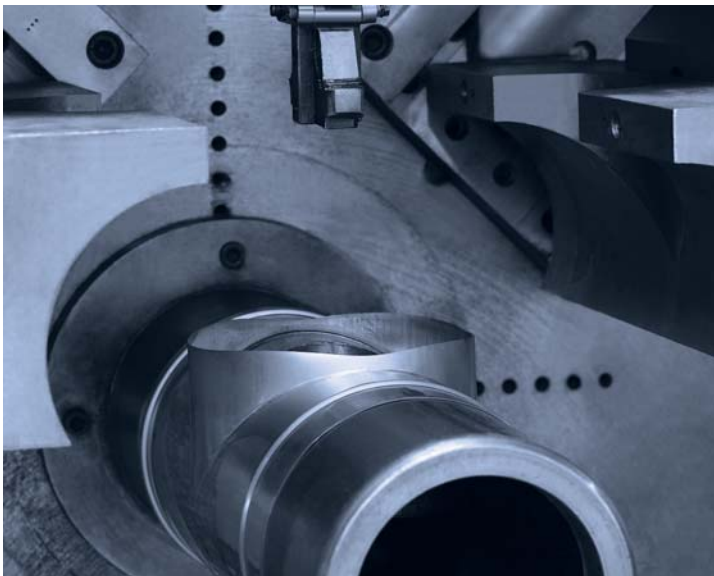

Solinox üretmiş olduğu ürünlerin şekil ve ölçülerinde önceden belirtmeksizin değişiklik yapma hakkını saklı tutar.





1020



Murat ankırlı İnřaat Mak. Gıda San. ve Tic. Ltd. řti.
Fevzi akmak Mah. 10646 Sk. No:6-8 Karatay - KONYA - TRKİYE
Tel : +90 332 239 18 07-08 Fax : +90 332 239 18 09
www.solinox.com.tr - info@solinox.com.tr